



Medium Voltage Fuse Links Full Line Catalogue





Cooper Bussmann, a division of Cooper Industries, is the leading source of circuit protection solutions in the global marketplace. Cooper Bussmann products are approved for use around the world and meet agency requirements and international standards: IEC, VDE, DIN, UL, CSA, BS and others.

Cooper Bussmann global headquarters are in St Louis, Missouri (US) and the European headquarters are in Burton-on-the-Wolds, Leicestershire (UK).

Cooper Bussmann manufactures over 50,000 part numbers covering extensive circuit protection solutions for a wide range of applications: residential, industrial, motor protection, power conversion, distribution, telecommunications, electronics and automotive.

Cooper Bussmann has been a leading exponent in the design, development and manufacture of medium voltage fuse links and their associated accessories for more than 90 years and has supplied fuse links to more than 90 countries worldwide.

The Cooper Bussmann team of specialist engineers plays a leading role in international standardisation of medium voltage fuse links, offering comprehensive advice on selection and applications.

With a continual commitment to meet our customers' needs with innovative high quality products with ISO 9002 'approval systems,' Cooper Bussmann is the supplier of choice for medium voltage circuit protection solutions, today.

Table of Contents



Introduction to Medium Voltage Fuse Link Technology.....	4 to 6
How to Order.....	7 to 8
DIN Fuse Links.....	9 to 24
Motor Fuse Links.....	25 to 34
Auxiliary Transformer Fuse Links.....	35 to 54
Oil Fuse Links.....	55 to 62
British Standard Air Fuse Links.....	63 to 75
US Style E-Rated Fuse Links.....	76 to 93
Fuse Clips.....	94 to 95
Expulsion Fuse Links.....	96 to 97
ASL - Automatic Sectionalising Links.....	98 to 101
Boric Acid Fuse Links.....	102 to 108
Cross References	
DIN Fuse Links.....	109 to 110
Motor Fuse Links.....	111
Voltage and Auxiliary Transformer Fuse Links.....	111
Oil Fuse Links.....	112
British Standard Air Fuse Links.....	113
US Style E-Rated Fuse Links.....	114 to 118
Boric Acid Fuse Links.....	119
Time-Current Curves and Cut-Off Curves List.....	120 to 121
Index.....	122

Introduction to Medium Voltage Fuse Link Technology

Offering unparalleled short-circuit interruption capabilities, Medium Voltage (MV) current-limiting fuse links are the principle protection device used by electrical utilities and switchgear manufacturers throughout the world. Safe, reliable, environmentally friendly and cost effective, MV fuse links are the protection device of choice for distribution circuits due to their speed of operation and **current limiting** ability in the event of a short-circuit fault.

The diagram below shows the operation of a fuse link interrupting a short-circuit fault, achieving a current zero well within the first half-cycle of a fault. Energy let-through into the site of a fault maybe typically only **1/500th of that of any other type of switching device.**

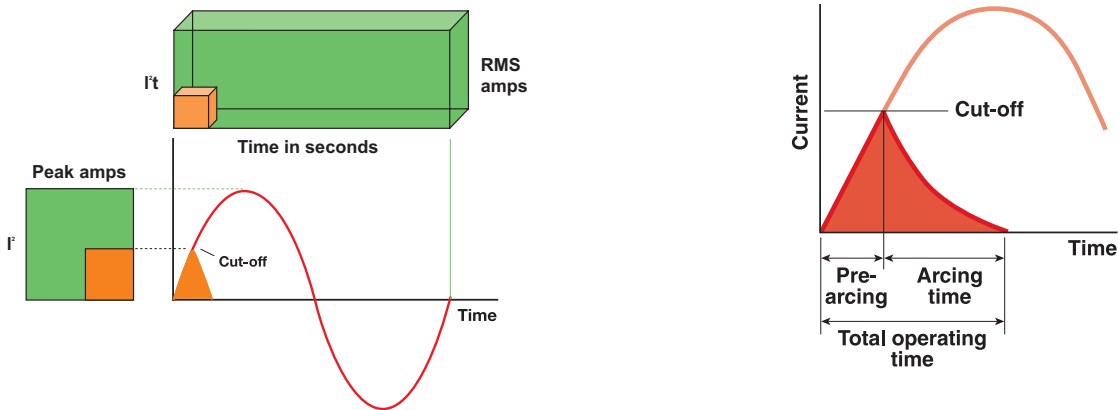

The speed of operation reduces the effect of short-circuit currents, dramatically limiting the energy delivered to the faulted circuit, preventing the catastrophic results of high faults and disturbing voltage arcs. The fuse link operation significantly limits the arc-flash hazard at the fault location. Improved power supply quality also results from the use of fuse links. High fault currents are interrupted in a few milliseconds, minimising voltage dips in system supply voltage.

Glossary for Medium Voltage Fuse Links

The following is a brief introduction to medium voltage fuse link technology. Some of the terms are also used in other areas of fuse technology.

- **Current rating/Rated current, I_n** - The rated current of the fuse link, given in amps.
- **Derating** - A reference to the fact that all MV fuse links must be derated once they are placed in a confined space, for example when mounted in switchgear. The fuse link must be derated to take into account the effect of heating on element resistance. Typically a fuse link is derated by between 5-20% depending on application.
- **Test Duty, TD** - A term used to refer to a specific type test within the IEC standard. Test Duty one (**TD1**), short-circuit test, Test Duty two (**TD2**), maximum arc energy test and Test Duty three (**TD3**), low overcurrent test.
- **Minimum Breaking Capacity Current, MBC, I_3** - The minimum current the fuse link can interrupt safely, without assistance from switchgear with instantaneous striker tripping.
- **Minimum Fusing Current (MFC)** - The minimum current which will cause the fuse link elements to **start to melt**.
- **I^2T** - The minimum value of pre-arcing and maximum value of total clearing energy a fuse link will allow to pass through it during short circuit operation, expressed as an amount of current (I^2), multiplied by time in seconds.
- **Watts Loss** - The power dissipation of the fuse link at a stated value of load current.
- **Breaking Capacity, I_1** - The maximum short circuit current the fuse link has been tested to in accordance with test Duty one (TD1), expressed in kA.
- **Resistance** - The resistance of the fuse link in free air at (20°C), measured in mΩ.

Introduction to Medium Voltage Fuse Link Technology

The main standard covering Medium Voltage (MV) fuse links is IEC 60282-1, 2009. IEC defines **MV** as from **1kV to 72.5kV**.

Current-limiting MV fuse links, split into three internationally recognised types: **Back-Up** (or sometimes called partial range), fuse links, which will interrupt any current from their rated breaking capacity down to a minimum breaking current, specified by the manufacturer. **General Purpose** MV fuse links will interrupt all currents that will melt the elements within one hour. **Full Range** MV fuse links can interrupt any current below the rated breaking capacity that melts the fuse elements satisfactorily. The diagram below illustrates the three performance criteria in terms of their minimum breaking current I_3 .

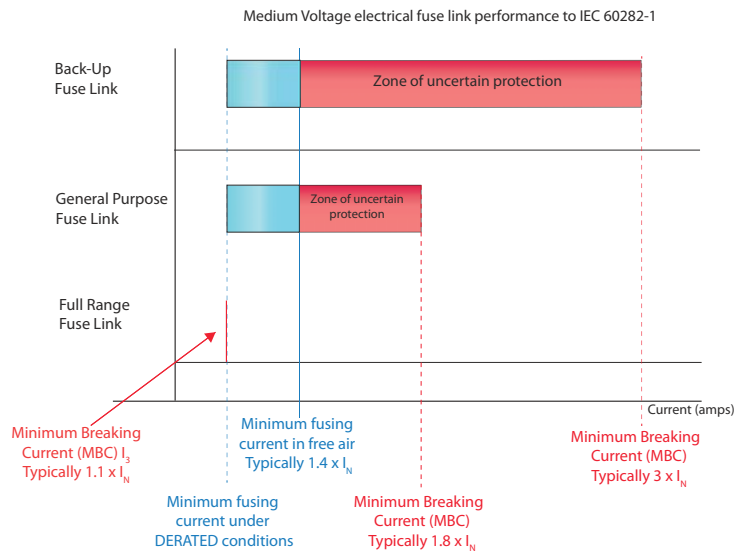

Current-limiting MV fuse links are similar in construction to Low Voltage (LV) cartridge types. Fuse elements do need to be much longer however to safely interrupt a medium voltage short-circuit. This is achieved by winding the elements round an internal core or holder, often called a star-core or spider; using this technique a one metre length element can be accommodated in a 250mm length body. The elements are surrounded by a pure, highly compacted granular quartz filler.

Like a LV fuse link, a MV fuse link has a ceramic body. Most current-limiting MV fuse links are also fitted with a striker mechanism. This is used to operate the trip bar or mechanism in a fuse-switch combination, fuse-switch or ring main unit (RMU) to achieve low overload fault interruption and three-phase disconnection.

Typically striker mechanisms are driven by a spring mechanism, triggered by a thin striker wire or striker coil running the length of the fuse link, connected in parallel to the fuse link elements. The striker coil is of much higher resistance than the fuse link elements, so a current only flows through the striker coil when the fuse link elements melt. The current heats up the striker coil and this in turn melts the wire retaining the spring, releasing it and pushing out the striker.

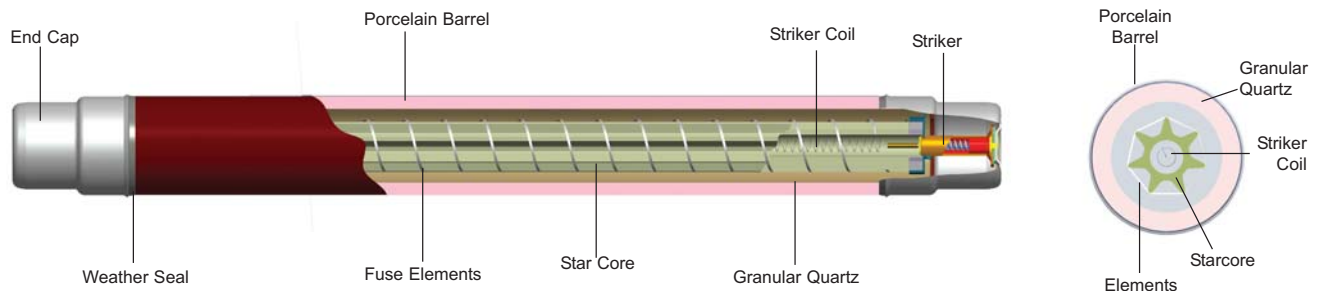

Introduction to Medium Voltage Fuse Link Technology

Non-Current Limiting

Essentially, non-current limiting fuse links have short elements and incorporate some means of lengthening the arc after the element melts, extinguishing the arc and preventing re-ignition. These are known as **expulsion fuse links**.

Expulsion fuse links are an effective way of protecting overhead distribution lines and transformers. They are designed for outdoor use only and comprise a tin or copper fuse element in series with a flexible braid in a tube. The tube forms one side of a triangle, with a latched connection at the top and a hinge at the bottom. The braid emerges from one end of the fuse link and is held in tension by a spring downwards under gravity. Under fault conditions, the fuse link swings downwards, the arc is lengthened, extinguished and prevented from restriking.

Thermal Effects of Low Overload Faults

During overload faults lasting a long time, it is possible for medium voltage (MV) elements to get very hot prior to actually melting. Given that silver has a melting temperature of 960°C, for fuse links with no temperature limitation, this can result in a fuse barrel temperature of over 400°C and 180°C at the insulating surface surrounding the fuse. To prevent deterioration of the insulation and to the fuse link itself, all MV fuse links should incorporate some form of technology to limit the thermal stress-heating, that is possible under prolonged low overload faults, often referred to as temperature limiting technology.

Since the launch of its first MV fuse links almost half a century ago, Cooper Bussmann has employed **M-effect technology** to achieve **temperature limitation** throughout its MV fuse link range. A small mass of special low melting point alloy is added to each fuse element, this has the effect of drastically reducing the temperature of the MV fuse link during operation. The larger cross section of the fuse link elements, made possible by use of this feature, ensures cooler running and lower power dissipation under normal service conditions than comparable temperature limitation technology.

Other manufacturers employ a temperature-limiting (or thermal) striker to overcome their overheating problems. In general with this approach the maximum temperatures reached by the fuse link and its surrounding insulation are not as low as with the use of M-effect. Such a solution is no more effective than use of M-effect on the fuse link elements and moreover does not bring the additional advantages of lower watts loss, cooler running and greater withstand against transient surge currents.

When a Cooper Bussmann fuse link operates under low overload fault conditions the maximum temperature rise of the fuse link is such that the temperature of the surrounding synthetic insulation remains below the temperature limits for all insulated fuse switchgear. The fuse barrel therefore remains intact and the fuse carrier and its contacts remain unimpaired.

Typically a Cooper Bussmann MV fuse link of a given rating may run 10-30°C cooler than comparable fuse links which do not employ M-effect. This advantage is particularly useful when the MV fuse link is used in totally enclosed all insulated switchgear, such as cast resin fuse-switches or compact SF6 insulated Ring Main Units (RMUs), or GIS HV switchgear, since less derating is required and hence a smaller rating of MV fuse link will do the same job as a higher rated MV fuse link from another manufacturer.

In short M-effect fuse links are generally safer, give better protection and are longer lasting than alternative designs, which do not employ these valuable features.

How to Order - Ordering Key

Symbol							Meaning
1	2	3	4	5	6	7	
x							Rated voltage of the fuse link in kV
	x						The type of fuse link given by a single letter
		x					Diameter of the fuse link barrel (in mm) denoted by a letter
			x				Length of the fuse link barrel (in mm) denoted by a letter
				x			Striker information: type of striker is denoted by a letter *
					x		Tag information: type denoted by a letter
						x	Current rating of the fuse link given in amperes

1 > Voltage

4 > Barrel length

*S = Spring striker 50N

2 > Type designation letter

5 > Striker information*

* E = Spring striker 80N

3 > Barrel diameter

6 > Tag information

* N = No striker fitted

* H or M = Pyrotechnic striker

Example: 12TDLEJ50

Ordering Code Information	Type Designation						
Rated voltage of the fuse link	12						
Type of fuse link		T					
Body diameter			D				
Body length				L			
Type of striker					E		
Type of tag						J	
Current rating							50
Complete part number	12	T	D	L	E	J	50

Part number **12TDLEJ50** represents an outdoor DIN fuse rated at **12kV** for use in **Air (T)** with a body diameter of **50.8mm (D)**, a barrel length of **292mm (L)**, a striker to **DIN 43625 80N (E)**, a tag arrangement to **DIN 43625 (J)** and an Amp rating of **50A**.

How to Order - Parts Referencing System

kV	1st Letter General Type	2nd Letter Barrel Diameter (mm)	3rd Letter Barrel Length (mm)	4th Letter Striker (mm)	5th/6th letter and or digit - termination or fixing	Amps A
	A, B, D, N = fuse links for use in air	M = 20.6	U = 86	S = Striker to DIN43625, form C 50N	A = No Tags. Ferrule diameter as the 2nd letter	
	V, W = fuse links primarily for use in motor circuits	B = 25.4	W = 142	E = Striker to DIN43625, 80N	B = Offset tag, single bolt fixing	
	F = fuse links with full range characteristics	D = 50.8	O = 192	H, M = Striker to BS2692-1	C, D = Tags to BS2692-1	
	O = fuse links sealed for use in oil switches	E, H, L = 63.5	C = 195	N = None fitted	F = Offset tag, double bolt fixing	
	T = DIN outdoor range	F, I, K = 76.2	D = 203		J = Ferrule to DIN 43625	
		X = 88	F = 254		O = Tags to BS2692-1	
			L = 292		6 = Tags to BS2692-1	
			G = 359		22 = 5/16-BSW stud one end only	
			N = 403		02, 03 = Double and triple barrel fuse link	
			M = 442		F2, F3 = Double and triple barrel fuse link	
			Q = 537			
			I = 565			
			K = 914			

Note:

Most of these fuse types are suitable for outdoor use. A variety of alternative tag arrangements are also available, details on request from Cooper Bussmann application engineers buletechnical@cooperindustries.com.

DIN Medium Voltage Fuse Links



Introduction to DIN Medium Voltage Fuse Links.....	10
Features and Benefits.....	11
General Guide to the Selection of DIN Fuse Links.....	12 - 14
3.6kV 'A' and 'W' Range Current Limiting Back-Up Fuse Links....	15
7.2kV 'T' Range Current Limiting Back-Up Fuse Links.....	16
12kV 'F' Range Current Limiting Full Range Fuse Links.....	17
12kV 'A' and 'T' Range Current Limiting Back-Up Fuse Links.....	18
17.5kV 'A' and 'T' Range Current Limiting Back-Up Fuse Links...	19 - 20
24kV 'F' Range Current Limiting Full Range Fuse Links.....	21
24kV 'A' and 'T' Range Current Limiting Back-Up Fuse Links.....	22
36kV 'T' Range Current Limiting Back-Up Fuse Links.....	23
Striker Force Diagrams.....	24

Introduction to DIN Medium Voltage Fuse Links

- Fuse links comply with DIN dimensional standard DIN 43625.
- 'F' Range, high performance full range fuse links.
- 'T' Range, high performance back-up fuse links, with striker tripping.
- 'A' Range, including high current rating back-up fuse link.
- Comply with IEC 60282-1 and VDE 0670 part 4.
- Wide variety of ratings, 3.6kV to 36kV.
- 'T' Range is suitable for outdoor use.
- Motor circuit fuse link option, see motor fuse links section page 25.



Cooper Bussmann 'T' Range

The Cooper Bussmann 'T' range medium voltage current-limiting fuse links to dimensional standard DIN 43625, are one of the most advanced design of medium voltage fuse links available anywhere in the world today. Developed by Cooper Bussmann, they comply with the very latest requirements of IEC 60282-1, are lead and cadmium free (meeting the RoHS and WEE directives) and have been designed to meet current and future global electrical utility specifications.

The 'T' range offers **time-current characteristics** that are **optimised** to improve discrimination with upstream devices, giving fast clearance of earth faults in secondary terminal zones. The fuse links utilise Cooper Bussmann M-effect technology, ensuring low power consumption during operation, while at the same time providing **temperature limitation in the event of an overload fault**.

The fuse links are suitable for both indoor and outdoor applications and are fitted with a spring striker. This gives either an output force of 80N with a travel of 30mm in the case of fuse links with part number sequence '**E**', or in the case of part number referring to '**S**', a spring striker with an output force of 50N and a maximum travel of 26mm.

Cooper Bussmann 'F' Range

The 'F' range fuse links have 'full range' clearing capability. Cooper Bussmann 'F' fuse links types are designed to clear low overloads right down to the fuse links' rated current in accordance with latest IEC 60282-1 requirements. They are thus suitable for use as a sole form of protection. 'F' range time-current characteristics are especially advantageous for transformer protection applications.

Cooper Bussmann 'A' Range

This earlier, well proven, design has values of minimum breaking current between the 'T' and 'F' range including higher current ratings.

Applications

MV DIN fuse links are suitable for primary side transformer protection, fuse switch combination unit, fuse bases and fuse switches.

Features & Benefits

Certification. The Cooper Bussmann Medium Voltage (MV) DIN range of fuse links has been fully tested and certified. Interrupting performance has been certified at the world class independent test laboratories of KEMA. All other performance requirements such as temperature-rise, time-current characteristics, weather sealing etc. have been thoroughly tested to ASTA approval procedures.

All Cooper Bussmann medium voltage DIN fuse links exhibit **cool running and low power dissipation** during normal operation in service. The use of **M-effect (as already explained), drastically reduces the temperature of the fuse link during operation.** The larger cross section of the fuse link elements made possible by using M-effect ensures cooler running and low power dissipation under normal service conditions. **This ensures maximum levels of network efficiency by reducing unnecessary power loss** and minimizing switchgear wear and tear due to the fact the fuse link is running much cooler during its service life.

Cool operation. When Cooper Bussmann MV fuse links operate under low fault conditions, the maximum temperature rise of the fuse link is well within the temperature limits for all switchgear due to the use of M-effect, ensuring fuse carrier contacts remain unimpaired, thereby **increasing the life cycle of the substation** and so **reducing capital and maintenance costs.**

Silver elements. All Cooper Bussmann Back-Up MV fuse links use 99.8% pure silver in their elements, ensuring high conductivity and **low power (revenue) loss, maximising network efficiency.**

Reduced nuisance operation due to surge currents. The use of M-effect allows a larger element cross section for a given current rating, **improving withstand capability** against transient overcurrents due to transformer magnetizing inrush current, reducing mal operation. **This improves system reliability reducing maintenance costs.**

Low arc voltages during short-circuit operation. Cooper Bussmann MV fuse links are designed to produce low levels of arc voltage, allowing fuse link **to be used down to half their rated voltage**, so during short-circuit operation, the switchgear and cables are not unduly stressed by being exposed to high arc voltages, thereby **prolonging the life of the switchgear and improving asset utilization.**

Additionally, **stock holdings and part numbers can be reduced**, as a 24kV Cooper Bussmann MV DIN fuse link can be used on a 12kV system. Utilities that run a mixed voltage network (say 24, 15.5, 13.8 12 and 10 kV) can **standardise on one type of switchgear** with one type of fuse link, **reducing costs** and **removing the need for an additional fuse extension and inventory.**

Construction. All electrical connections within the Cooper Bussmann MV fuse link are made by welded or brazed joints. This firstly ensures a **very mechanically robust fuse link** and secondly, greatly **reduces the risk of poor intermittent internal contacts, improving substation reliability.**

X-Ray. All Cooper Bussmann MV fuse links are X-rayed during production. Element alignment, M-effect position, etc are all checked by trained operators. This process ensures defects that would not normally be detected by purely visual or electrical based quality systems, to be captured during production.

Element Design. Unlike many other medium voltage fuse link manufacturers, Cooper Bussmann medium voltage fuse elements employ a “neck” or ‘notch’ design principle as opposed to a perforated element design principle, see diagram below.



This element design insures that even the smallest degree of accidental element damage is easily detected during testing, as part of the manufacturing process thus avoids the possibility of such imperfect fuses being put into service. This is far more difficult to achieve with perforated element designs.

Lead and Cadmium Free. All Cooper Bussmann ‘T’ Ranges fuse links are lead and cadmium free and meet with the latest WEEE and RoHS directives. RoHS is less than 1000Vac.

Recycling Scheme. Cooper Bussmann operates a recycling scheme for all medium voltage fuse links, please contact buletechnical@cooperindustries.com for further information.

General Guide to the Selection of DIN Back-Up Fuse Links

Back-Up Fuse Links

- Selection guide using Low Voltage fuse links operating class gG/gL on low voltage side for individual cable exit protection see figure 1.

Fuse Links Type	Transformer Rating	Transformer Primary Voltage					
		10kV		20kV		30kV	
		Rated Current of the Medium Voltage Fuse Link		Rated Current of the Medium Voltage Fuse Link		Rated Current of the Medium Voltage Fuse Link	
(kVA)	Min	Max	Min	Max	Min	Max	
Back-Up Fuse Links	50	6.3	10	6.3	6.3	3.15	3.15
	100	16	25	6.3	10	6.3	10
	125	16	25	10	16	6.3	10
	160	20	31.5	10	20	6.3	10
	200	20	40	16	25	10	16
	250	25	50	16	25	10	16
	315	31.5	63	20	31.5	16	16
	400	40	80	20	40	16	25
	500	50	100	25	50	16	31.5
	630	63	125	31.5	63	20	40
	800	80	125	40	63	25	40
	1000	100	125	50	80	31.5	50
	1250	125	200	63	80	40	50
	1600	160	200	71	125	50	63
2000	200	200	100	160	63	63	

- Selection guide using Low Voltage fuse links operation class gG/gL on low voltage side for overload protection of the transformer, see figure 2.

Fuse Links Type	Transformer Rating	Transformer Primary Voltage						Low Voltage NH Fuse Size gG/gL (A)
		10kV		20kV		30kV		
		Rated Current of the Medium Voltage Fuse Link		Rated Current of the Medium Voltage Fuse Link		Rated Current of the Medium Voltage Fuse Link		
(kVA)	Min	Max	Min	Max	Min	Max		
Back-Up Fuse links	50	10	10	6.3	6.3	3.15	3.15	63
	100	16	25	10	10	6.3	10	125
	125	20	25	10	16	6.3	10	160
	160	25	31.5	16	20	10	10	200
	200	31.5	40	16	25	16	16	250
	250	40	50	20	25	16	16	315
	315	50	63	25	31.5	16	20	400
	400	63	80	31.5	40	20	25	500
	500	80	100	40	50	25	31.5	630
	630	100	125	63	63	31.5	40	800
	800	125	160	63	63	40	40	1000
	1000	200	200	80	80	50	50	1250

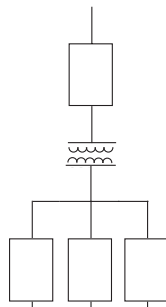

Figure 1

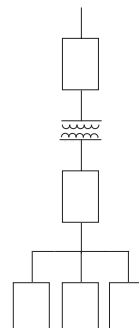

Figure 2

General Guide to the Selection of DIN Back-UP and Full Range Fuse Links

Back-Up Fuse Links

- Selection guide according to DIN VDE 0670 part 402 using LV fuse links operating class gTr on low voltage side for overload current protection of the transformer (for German market only), see figure 2 opposite page.

Fuse Links Type	Transformer Rating	Transformer Primary Voltage						Low Voltage NH Fuse Size gTr (A)
		10kV		20kV		30kV		
		Rated Current of the Medium Voltage Fuse Link		Rated Current of the Medium Voltage Fuse Link		Rated Current of the Medium Voltage Fuse Link		
	(kVA)	Min	Max	Min	Max	Min	Max	
Back-Up Fuse Links	100	16	16	10	10	6.3	6.3	100
	125	16	16	10	10	10	10	125
	160	20	25	16	16	10	10	160
	200	25	31.5	16	16	16	16	200
	250	31.5	40	16	25	16	20	250
	315	40	50	25	25	20	25	315
	400	50	63	25	31.5	25	25	400
	500	63	80	31.5	40	25	31.5	500
	630	80	100	40	50	31.5	40	630
	800	100	125	63	63	40	50	800
	1000	125	160*	63	80	40	50	1000

Full Range Fuse Links

- Selection guide using Low Voltage fuse links operating class gG/gL on low voltage side for individual cable exit protection, see figure 1 opposite page.

Fuse Links Type	Transformer Rating	Transformer Primary Voltage			
		10kV		20kV	
		Rated Current of the Medium Voltage Fuse-Link		Rated Current of the Medium Voltage Fuse-Link	
	(kVA)	Min	Max	Min	Max
Full Range Fuse Links	50	6.3	10	6.3	6.3
	100	10	20	6.3	10
	125	16	25	6.3	16
	160	16	31.5	10	16
	200	20	40	10	20
	250	25	50	16	25
	315	31.5	63	16	31.5
	400	40	80	20	40
	500	50	100	25	45
	630	63	100	31.5	45
	800	80	100	40	45
1000	100	100	45	45	

- Selection guide using Low Voltage fuse links operating class gG/gL on low voltage side for overload protection of the transformer, see figure 2 opposite page

Fuse Links Type	Transformer Rating	Transformer Primary Voltage				Low Voltage NH Fuse Size gG/gL (A)
		10kV		20kV		
		Rated Current of the Medium Voltage Fuse Link		Rated Current of the Medium Voltage Fuse Link		
	(kVA)	Min	Max	Min	Max	
Full Range Fuse links	50	6.3	6.3	6.3	6.3	80
	100	10	10	10	10	125
	125	16	16	10	10	160
	160	16	20	16	16	200
	200	20	31.5	16	16	250
	250	31.5	40	16	20	315
	315	40	40	20	20	400
	400	40	63	25	31.5	500
	500	50	63	31.5	40	630
	630	100	100	40	45	800
	800	100	100	-	-	1000

General Guide to the Selection of DIN Full Range Fuse Links

Full Range Fuse Links

- Selection guide according to DIN VDE 0670 part 402 using Low Voltage fuse links operating class gTr on low voltage side for overload protection of the transformer (for German market only), figure 2 page 12

Fuse Links Type	Transformer Rating	Transformer Primary Voltage				Low Voltage NH Fuse Size gG/gL
		10kV		20kV		
		Rated Current of the Medium Voltage Fuse Link		Rated Current of the Medium Voltage Fuse Link		
	(kVA)	Min	Max	Min	Max	(A)
Full Range Fuse links	100	10	20	6.3	10	100
	125	16	25	10	16	125
	160	16	31.5	10	16	160
	200	20	40	16	20	200
	250	25	50	20	25	250
	315	40	63	20	31.5	315
	400	40	80	25	40	400
	500	50	100	31.5	45	500
	630	80	100	40	45	630
	800	100	100	45	45	800
	1000	100	100	-	-	1000

- Selection of these MV fuse links has been based on the following:
 - 1 - The fuse link should withstand transformer magnetising inrush currents, taken as 12 times full load current for 0.1 seconds.
 - 2 - The fuse link should discriminate with the rating of the secondary fuse link stated or where only individual cable exit protection exists, the highest LV fuse link rating likely to be used.
 - 3 - The fuse link should operate within two seconds for transformers complying with IEC 60076-5 in respect of impedance, voltage and short-circuit withstand current.
 - 4 - The fuse link should operate reasonably quickly in the event of a transformer internal fault or an earth fault in the secondary terminal zone of the transformer.
 - 5 - In the case where there is no secondary fuse link for overload protection, the minimum recommended MV fuse link rating applies to the use of fuse links in encapsulated enclosures where permissible continuous overload is generally limited to 120% of transformer full load current. However, if greater overload currents are permissible a higher rating of fuse link may be required. Where the fuse link is used in open air or conditions of unrestricted ventilation a higher permissible overload may be possible.
 - 6 - In most cases more than one rating of MV fuse link is recommended for a particular transformer size. Choice of fuse link will then depend on which fuse link offers the best protection; e.g., having one fuse link for several transformer sizes.

Recommendations for other voltage are available on request, please email buletechnical@cooperindustries.com.

3.6kV - 'A & W' Range Current Limiting Back-Up Fuse Links

Specifications

Description: A range of medium voltage DIN fuse links, complete with striker, suitable for transformer protection. The fuse links can be used even when there is no secondary low voltage protection, provided they are used with fuse switches fitted with instantaneous striker tripping mechanism.

Ratings:

Rated Voltage: 3.6kV
 Rated Current: 6.3 - 200A
 Breaking Capacity: 40 - 50kA

Agency Information: Comply with DIN Dimensional standard DIN 43625, VDE 0670 part 4 and with IEC 60282-1 (2005).
 Suitable for indoor use.

Time-Current Curves and Cut-Off Curves: see list page 120 and data on CD at the back of the catalogue.

Dimensions (mm):

Fuse Reference	A	C	D	Weight (Kg)
ADLSJ	292	54	51	1.63
ADOSJ	192	54	51	1.1
WDOSJ	192	54	51	1.1
WFOSJ	192	76	76	2.1



Features and Benefits

- *Cool running, low watts loss and power dissipation* thanks to the M-effect ensuring high levels of substation utilisation
- *Silver elements* ensuring high conductivity and low power (revenue) loss
- *100% X-ray*, all our Medium Voltage fuse links are X-rayed ensuring the highest possible standards are maintained

Typical Applications

- Primary side transformer protection
- Used in fuse switch combination unit
- Used in fuse bases
- Used in fuse switches

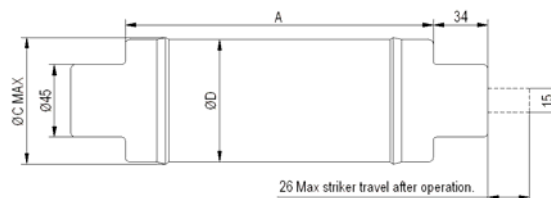

Part Numbers

Part Number	Rated Current I_n (A)	Breaking Capacity I_1 (kA)	Minimum Breaking Current I_3 (A)	Cold Resistance & Watts Loss in Free Air		Joule Integral (I^2t)		Length mm	Diameter mm	Weight kg
				mΩ	W	Minimum Pre-Arcing	Maximum Operating			
3.6ADLSJ6.3	6.3	40	13	158	9	4.5×10^1	1.9×10^2	292	51	1.63
3.6ADLSJ10	10	40	13	95.6	13	1.3×10^2	5.4×10^2	292	51	1.63
3.6ADLSJ16	16	40	20	63.3	22	3×10^2	1.3×10^3	292	51	1.63
3.6ADLSJ20	20	40	31	45.9	25	6.3×10^2	2.7×10^3	292	51	1.63
3.6ADLSJ25	25	40	106	28.7	25	1.3×10^2	1.2×10^3	292	51	1.63
3.6ADLSJ31.5	31.5	40	106	19.1	26	2.9×10^2	2.7×10^3	292	51	1.63
3.6ADLSJ40	40	40	106	11.4	25	8×10^2	7.5×10^3	292	51	1.63
3.6ADOSJ6.3	6.3	40	13	158	9	4.5×10^1	1.9×10^2	192	51	1.1
3.6ADOSJ10	10	40	31	79.2	11	2.3×10^2	9.7×10^2	192	51	1.1
3.6ADOSJ16	16	40	49	50.8	18	5.5×10^2	2.4×10^3	192	51	1.1
3.6ADOSJ20	20	40	49	38.1	21	9.8×10^2	4.2×10^3	192	51	1.1
3.6ADOSJ25	25	40	106	28.9	25	1.3×10^2	1.2×10^3	192	51	1.1
3.6ADOSJ31.5	31.5	40	106	19.2	26	2.9×10^2	2.7×10^3	192	51	1.1
3.6ADOSJ40	40	40	106	11.6	26	8.0×10^2	7.5×10^3	192	51	1.1
3.6WDOSJ50	50	50	180	5.36	20	1.8×10^3	2.4×10^4	192	51	1.1
3.6WDOSJ63	63	50	225	3.68	21	3.8×10^3	4.5×10^4	192	51	1.1
3.6WDOSJ80	80	50	288	2.88	27	6.3×10^3	8.0×10^4	192	51	1.1
3.6WDOSJ100	100	50	360	2.16	31	9.8×10^3	1.1×10^5	192	51	1.1
3.6WDOSJ125	125	50	450	1.73	39	1.5×10^4	2.2×10^5	192	51	1.1
3.6WFOSJ160	160	50	600	1.28	47	3.1×10^4	6.2×10^5	192	76	2.1
3.6WFOSJ200	200	50	600	0.938	52	5.7×10^4	1.1×10^6	192	76	2.1

Data Sheet 720102

7.2kV - 'T' Range Current Limiting Back-Up Fuse Links

Specifications

Description: A range of medium voltage DIN fuse links complete with striker, suitable for transformer protection. The fuses can be used even when there is no secondary low voltage protection, provided they are used with fuse switches fitted with instantaneous striker tripping.

Ratings:

Rated Voltage: 3.0 - 7.2kV
 Rated Current: 6.3 - 160A
 Breaking Capacity: 40kA

Agency Information: Comply with DIN Dimensional standard DIN 43625, VDE 0670 part 4 and with IEC 60282-1 (2005). Suitable for indoor and outdoor use.

Time-Current Curves and Cut-Off Curves: see list page 120 and data on CD at the back of the catalogue.

Dimensions (mm):

Fuse Reference	A	C	D	Weight (Kg)
TDLSJ	292	54	51	1.63
TFLSJ	292	80	76	3.1

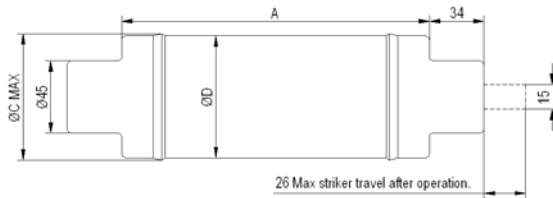

Features and Benefits

- *Cool running, low watts loss and power dissipation* thanks to the M-effect ensuring high levels of substation utilisation
- *Silver elements* ensuring high conductivity and low power (revenue) loss
- *100% X-ray*, all our Medium Voltage fuse links are X-rayed ensuring the highest possible standards are maintained

Typical Applications

- Primary side transformer protection
- Used in fuse switch combination unit
- Used in fuse bases
- Used in fuse switches

Part Numbers

Part Number	Rated Current I_n (A)	Breaking Capacity I_1 (kA)	Minimum Breaking Current I_3 (A)	Cold Resistance & Watts Loss in Free Air		Joule Integral (I^2t)		Length mm	Diameter mm	Weight kg
				mΩ	W	Minimum Pre-Arcing	Maximum Operating			
7.2TDLSJ6.3	6.3	40	20	205	11	4.8×10^1	6.5×10^3	292	51	1.63
7.2TDLSJ10	10	40	31	99.7	19	2.5×10^2	2.7×10^3	292	51	1.63
7.2TDLSJ16	16	40	49	65.1	23	5.5×10^2	8.2×10^3	292	51	1.63
7.2TDLSJ20	20	40	49	48.9	27	9.7×10^2	1.1×10^4	292	51	1.63
7.2TDLSJ25	25	40	80	32.6	28	5.7×10^2	8.0×10^3	292	51	1.63
7.2TDLSJ31.5	31.5	40	100	26.0	36	8.9×10^2	1.0×10^4	292	51	1.63
7.2TDLSJ40	40	40	114	16.0	36	2.0×10^3	2.2×10^4	292	51	1.63
7.2TDLSJ50	50	40	143	12.9	46	3.2×10^3	3.2×10^4	292	51	1.63
7.2TDLSJ63	63	40	180	8.14	45	8.0×10^3	7.5×10^4	292	51	1.63
7.2TFLSJ80	80	40	264	6.01	54	5.0×10^3	6.5×10^4	292	76	3.1
7.2TFLSJ100	100	40	338	4.65	64	9.1×10^3	1.1×10^5	292	76	3.1
7.2TFLSJ125	125	40	375	3.60	79	1.5×10^4	1.7×10^5	292	76	3.1
7.2TFLSJ160	160	40	525	2.73	97	3.0×10^4	3.1×10^5	292	76	3.1

12kV - 'F' Range Current Limiting Full Range Fuse Links

Specifications

Description: A range of medium voltage DIN fuse links, complete with sealed striker, suitable for transformer protection. Cooper Bussmann 'F' range provide full range protection.

Ratings:

Rated Voltage: 12kV
 Rated Current: 6.3 - 100A
 Breaking Capacity: 50kA

Agency Information: Comply with DIN Dimensional standard DIN 43625, VDE 0670 part 4, VDE 0670 part 402 and with IEC 60282-1 (2005)
 Suitable for indoor use.

Time-Current Curves and Cut-Off Curves: see list page 120 and data on CD at the back of the catalogue.

Dimensions (mm):

Fuse Reference	A	C	D	Weight (Kg)
FDLSJ	292	54	51	1.63
FFLSJ	292	80	76	3.16
FXLSJ	292	92	88	4

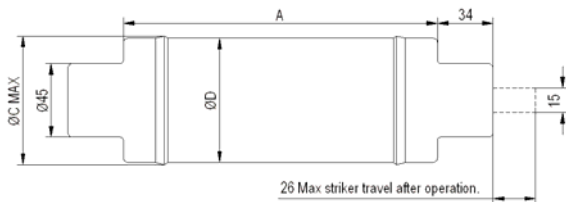

Features and Benefits

- *Cool running, low watts loss and power dissipation* thanks to the M-effect ensuring high levels of substation utilisation
- *Silver elements* ensuring high conductivity and low power (revenue) loss
- *100% X-ray*, all our Medium Voltage fuse links are X-rayed ensuring the highest possible standards are maintained
- Our Full Range MV fuse links can interrupt any current below the rated breaking capacity.

Typical Applications

- Primary side transformer protection
- Used in fuse switch combination unit
- Used in fuse bases without instantaneous striker tripping
- Used in fuse switches

Part Numbers

Part Number	Rated Current I_n (A)	Breaking Capacity I_1 (kA)	Minimum Breaking Current I_3 (A)	Cold Resistance & Watts Loss in Free Air		Joule Integral (I^2t)		Length mm	Diameter mm	Weight kg
				mΩ	W	Minimum Pre-Arcing	Maximum Operating			
12FDLSJ6.3	6.3	50	6.3	208	10	6.9×10^1	6.3×10^2	292	51	1.63
12FDLSJ10	10	50	10	116	15	2.2×10^2	2.1×10^3	292	51	1.63
12FDLSJ16	16	50	16	55.4	17	8.8×10^2	3.9×10^3	292	51	1.63
12FDLSJ20	20	50	20	39.6	20	1.7×10^3	7.6×10^3	292	51	1.63
12FDLSJ25	25	50	25	31.2	26	2.8×10^3	1.3×10^4	292	25.8	1.63
12FDLSJ31.5	31.5	50	31.5	26.4	36	2.6×10^3	1.3×10^4	292	51	1.63
12FFLSJ40	40	50	40	19.7	42	3.8×10^3	3.8×10^4	292	76.2	3.16
12FFLSJ50	50	50	50	14.8	51	6.8×10^3	5.6×10^4	292	76.2	3.16
12FFLSJ63	63	50	63	12.4	72	5.1×10^3	5.4×10^4	292	76.2	3.16
12FXLSJ80	80	50	80	7.94	72	2.2×10^4	1.1×10^5	292	88	4
12FXLSJ100	100	50	100	5.64	82	4.2×10^4	2×10^5	292	88	4

12kV - 'A' and 'T' Range Current Limiting Back-Up Range Fuse Links

Specifications

Description: A range of medium voltage DIN fuse links, complete with sealed striker, suitable for transformer protection. The fuse links can be used even when there is no secondary low voltage protection, provided they are used with fuse switches fitted with instantaneous striker tripping.

Ratings:

Rated Voltage: 6 - 12kV
 Rated Current: 6.3 - 200A
 Breaking Capacity: 50 - 63kA

Agency Information: Comply with DIN Dimensional standard DIN 43625, VDE 0670 part 4, VDE 0670 part 402 and with IEC 60282-1 (2005)
 Suitable for indoor and outdoor use.

Time-Current Curves and Cut-Off Curves: see list page 120 and data on CD at the back of the catalogue.

Dimensions (mm):

Fuse Reference	A	C	D	Weight (Kg)
AILSJ	292	79	76	3.3
TDLEJ	292	54	51	1.7
THLEJ	292	67	64	2.6
TKLEJ	292	80	76	3.5
TXLEJ	292	88	88	3.7
TFMSJ	442	80	76	5.1

EJ Outline

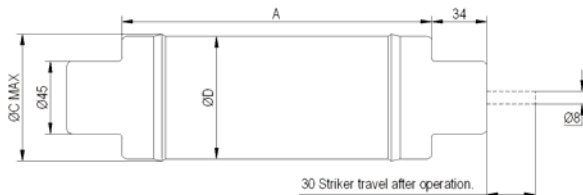

Features and Benefits

- *Cool running, low watts loss and power dissipation* thanks to the M-effect ensuring high levels of substation utilisation
- *Silver elements* ensuring high conductivity and low power (revenue) loss
- *100% X-ray*, all our high voltage fuse links are X-rayed ensuring the highest possible standards are maintained

Typical Applications

- Primary side transformer protection
- Used in fuse switch combination unit
- Used in fuse bases
- Used in fuse switches

SJ Outline

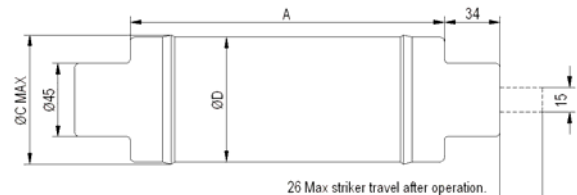

Part Number	Rated Current I _n (A)	Breaking Capacity I ₁ (kA)	Minimum Breaking Current I ₃ (A)	Cold Resistance & Watts Loss in Free Air		Joule Integral (I ² t)		Length mm	Diameter mm	Weight kg
				mΩ	W	Minimum Pre-Arcing	Maximum Operating			
12AILSJ100*	100	31.5	176	5.03	70	1.4 x 10 ⁴	2 x 10 ⁵	292	76	3.3
12TDLEJ6.3	6.3	63	23	222	10	9.8 x 10 ¹	1.0 x 10 ³	292	51	1.7
12TDLEJ10	10	63	35	131	16	2.8 x 10 ²	2.3 x 10 ³	292	51	1.7
12TDLEJ16	16	63	53	54.6	16	2.6 x 10 ²	3.9 x 10 ³	292	51	1.7
12TDLEJ20	20	63	73	39.1	18	5.2 x 10 ²	5.4 x 10 ³	292	51	1.7
12TDLEJ25	25	63	87	31.2	24	8.1 x 10 ²	8.4 x 10 ³	292	51	1.7
12TDLEJ31.5	31.5	63	111	23.4	28	1.4 x 10 ³	1.5 x 10 ⁴	292	51	1.7
12TDLEJ40	40	63	143	17.2	36	2.4 x 10 ³	2.5 x 10 ⁴	292	51	1.7
12TDLEJ50	50	63	168	13.5	47	2.8 x 10 ³	3.1 x 10 ⁴	292	51	1.7
12TDLEJ63	63	63	235	10.6	60	4.3 x 10 ³	4.7 x 10 ⁴	292	51	1.7
12THLEJ80	80	63	272	7.81	72	7.9 x 10 ³	9.1 x 10 ⁴	292	64	2.6
12THLEJ100	100	63	388	5.74	85	2.0 x 10 ⁴	1.4 x 10 ⁵	292	64	2.6
12TKLEJ125	125	63	687	3.99	93	4.0 x 10 ⁴	3.5 x 10 ⁵	292	76	3.5
12TXLEJ160**	160	63	560	4.30	217	1.1 x 10 ⁵	5.0 x 10 ⁵	292	88	3.7
12TXLEJ200**	200	63	610	3.80	333	1.5 x 10 ⁵	6.5 x 10 ⁵	292	88	3.7
12THMEJ100	100	63	272	5.74	85	2.0 x 10 ⁴	1.4 x 10 ⁵	442	64	3.7
12TFMSJ160	160	50	485	3.65	139	5.0 x 10 ⁴	3.5 x 10 ⁵	442	76	5.1

* Not suitable for outdoor use / ** Not compliant with VDE 0670 part 402

Data Sheet for 'T' range 720104

17.5kV - 'A' and 'T' Range Current Limiting Back-Up Fuse Links

Specifications

Description: A range of medium voltage DIN fuse links, complete with sealed striker, suitable for transformer protection. The fuse links can be used even when there is no secondary low voltage protection, provided they are used with fuse switches fitted with instantaneous striker tripping.

Ratings:

Rated Voltage: 10 - 17.5kV
 Rated Current: 6.3 - 125A
 Breaking Capacity: 20 - 50kA

Agency Information: Comply with DIN Dimensional standard DIN 43625, VDE 0670 part 4, VDE 0670 part 402 and with IEC 60282-1 (2005).

'A' range is suitable for indoor use.

'T' range is suitable for indoor and outdoor use .

Time-Current Curves and Cut-Off Curves: see list page 120 and data on CD at the back of the catalogue.

Dimensions (mm):

Fuse Reference	A	C	D	Weight (Kg)
AILSJ	442	79	76	4.5
AIMSJ	442	79	76	4.5
TDLSJ	292	54	51	1.7
TFLSJ	292	80	76	3.1
TDMEJ	442	54	51	2.5
THMEJ	442	67	64	3.7
TKMEJ	442	80	76	5.1



Features and Benefits

- *Cool running, low watts loss and power dissipation* thanks to the M-effect ensuring high levels of substation utilisation
- *Silver elements* ensuring high conductivity and low power (revenue) loss
- *100% X-ray*, all our high voltage fuse links are X-rayed ensuring the highest possible standards are maintained

Typical Applications

- Primary side transformer protection
- Used in fuse switch combination unit
- Used in fuse bases
- Used in fuse switches

EJ Outline

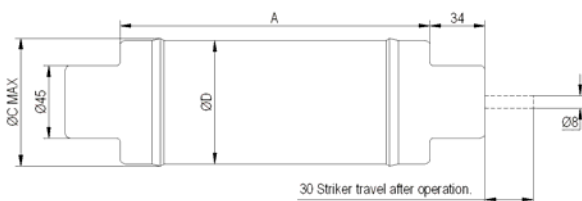

SJ Outline

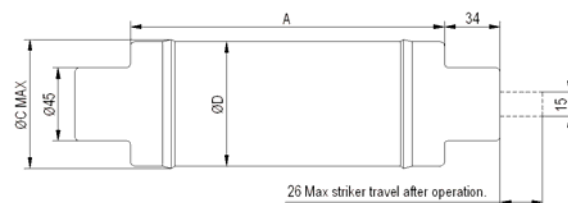

17.5kV - 'A' and 'T' Range Current Limiting Back-Up Fuse Links

Part Numbers

Part Number	Rated Current I_n (A)	Breaking Capacity I_1 (kA)	Minimum Breaking Current I_3 (A)	Cold Resistance & Watts Loss in Free Air		Joule Integral (I^2t)		Length mm	Diameter mm	Weight kg
				m Ω	W	Minimum Pre-Arcing	Maximum Operating			
17.5AILSJ40*	100	25	176	7.33	102	1.4 x 10 ⁴	2 x 10 ⁵	442	76	4.5
17.5AILSJ50*	50	20	137	29.5	102	1.8 x 10 ³	2.9 x 10 ⁴	442	76	4.5
17.5AILSJ63*	63	20	125	23.6	130	3.2 x 10 ³	4.5 x 10 ⁴	442	76	4.5
17.5AIMSJ100*	71	20	176	15.1	106	6.3 x 10 ³	8.5 x 10 ⁴	442	76	4.5
17.5TDLSJ6.3*	6.3	35.5	23	313	15	4.8 x 10 ¹	6.1 x 10 ²	292	51	1.7
17.5TDLSJ10*	10	35.5	19	185	23	2.8 x 10 ²	4.0 x 10 ³	292	51	1.7
17.5TDLSJ16*	16	35.5	59	104	34	2.9 x 10 ²	2.0 x 10 ³	292	51	1.7
17.5TDLSJ20*	20	35.5	80	69.2	38	5.7 x 10 ²	4.4 x 10 ³	292	51	1.7
17.5TDLSJ25*	25	35.5	100	55.4	48	8.9 x 10 ²	6.6 x 10 ³	292	51	1.7
17.5TDLSJ31.5*	31.5	35.5	118	41.4	58	5.1 x 10 ²	1.1 x 10 ⁴	292	51	1.7
17.5TDLSJ40*	40	35.5	148	31.1	76	8.0 x 10 ²	1.8 x 10 ⁴	292	51	1.7
17.5TFLSJ50*	50	35.5	225	17.3	62	8.1 x 10 ³	6.0 x 10 ⁴	292	76	3.1
17.5TDM EJ6.3	6.3	50	25	324	14	9.8 x 10 ¹	1.0 x 10 ³	442	51	2.5
17.5TDM EJ10	10	50	36	192	24	2.8 x 10 ²	2.3 x 10 ³	442	51	2.5
17.5TDM EJ16	16	50	55	79.6	23	2.6 X 10 ²	3.9 x 10 ³	442	51	2.5
17.5TDM EJ20	20	50	69	57.0	27	5.2 x 10 ²	5.4 x 10 ³	442	51	2.5
17.5TDM EJ25	25	50	87	45.5	34	8.1 x 10 ²	8.4 x 10 ³	442	51	2.5
17.5TDM EJ31.5	31.5	50	87	34.1	41	1.4 x 10 ³	1.5 x 10 ⁴	442	51	2.5
17.5TDM EJ40	40	50	111	25.0	53	2.4 x 10 ³	2.5 x 10 ⁴	442	51	2.5
17.5TDM EJ50	50	50	174	19.7	69	2.8 x 10 ³	3.1 x 10 ⁴	442	51	2.5
17.5TDM EJ63	63	50	200	15.4	89	4.3 x 10 ³	4.7 x 10 ⁴	442	51	2.5
17.5THMEJ80	80	50	270	11.5	108	7.9 x 10 ³	9.1 x 10 ⁴	442	64	3.7
17.5THMEJ100	100	50	376	8.38	127	2.0 x 10 ⁴	1.4 x 10 ⁵	442	64	3.7
17.5TKMEJ125	125	50	467	5.95	146	3.4 x 10 ⁴	3.5 x 10 ⁵	442	76	5.1

* Not suitable for outdoor use

** Not compliant with VDE 0670 part 402

24kV - 'F' Range Current Limiting Full Range Fuse Links

Specifications

Description: A range of medium voltage DIN fuse links, complete with sealed striker, suitable for transformer protection. Cooper Bussmann 'F' range provide full range protection.

Ratings:

Rated Voltage: 24kV
 Rated Current: 6.3 - 45A
 Breaking Capacity: 35.5kA

Agency Information: Comply with DIN Dimensional standard DIN 43625, VDE 0670 part 4, VDE 0670 part 402 and with IEC 60282-1 (2005). Suitable for indoor use.

Time-Current Curves and Cut-Off Curves: see list page 120 and data on CD at the back of the catalogue.

Dimensions (mm):

Fuse Reference	A	C	D	Weight (Kg)
FDMSJ	442	54	51	2.2
FFMSJ	442	67	76	4.5

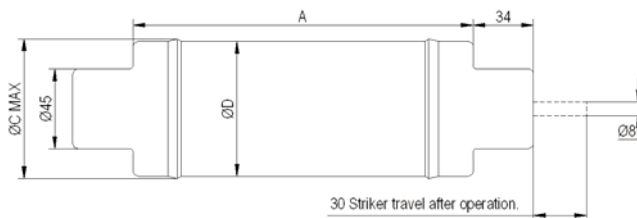

Features and Benefits

- *Cool running, low watts loss and power dissipation* thanks to the M-effect ensuring high levels of substation utilisation
- *Silver elements* ensuring high conductivity and low power (revenue) loss
- *100% X-ray*, all our high voltage fuse links are X-rayed ensuring the highest possible standards are maintained
- Our Full Range MV fuse links can interrupt any current below the rated breaking capacity.

Typical Applications

- Primary side transformer protection
- Used in fuse switch combination unit
- Used in fuse bases without instantaneous striker tripping
- Used in fuse switches

Part Numbers

Part Number	Rated Current I_n (A)	Breaking Capacity I_1 (kA)	Minimum Breaking Current I_3 (A)	Cold Resistance & Watts Loss in Free Air		Joule Integral (I^2t)		Length mm	Diameter mm	Weight kg
				mΩ	W	Minimum Pre-Arcing	Maximum Operating			
24FDMSJ6.3	6.3	35.5	6.3	437	21	6.8×10^1	5.4×10^2	442	51	2.2
24FDMSJ10	10	35.5	10	218	29	2.7×10^2	2.1×10^3	442	51	2.2
24FDMSJ16	16	35.5	16	118	39	8.2×10^2	2.7×10^3	442	51	2.2
24FDMSJ20	20	35.5	20	82.2	43	1.6×10^3	5.1×10^3	442	51	2.2
24FDMSJ25	25	35.5	25	54.7	48	3.4×10^3	1.2×10^4	442	51	2.2
24FDMSJ31.5	31.5	35.5	31.5	48.6	71	3.2×10^3	1.2×10^4	442	51	2.2
24FFMSJ25	25	35.5	25	58.6	47	3.4×10^3	1.1×10^4	442	76.2	4.5
24FFMSJ31.5	31.5	35.5	31.5	48.8	70	4.7×10^3	1.5×10^4	442	76.2	4.5
24FFMSJ40	40	35.5	40	38.4	85	7.6×10^3	2.5×10^4	442	76.2	4.5
24FFMSJ45	45	35.5	45	31.4	92	7.2×10^3	3×10^4	442	76.2	4.5

24kV - 'A' and 'T' Range Current Limiting Back-Up Fuse Links

Specifications

Description: A range of medium voltage DIN fuse links, complete with sealed striker, suitable for transformer protection. The fuse links can be used even when there is no secondary low voltage protection, provided they are used with fuse switches fitted with instantaneous striking.

Ratings:

Rated Voltage: 12 - 24kV
 Rated Current: 6.3 - 160A
 Breaking Capacity: 20 - 63kA

Agency Information: Comply with DIN Dimensional standard DIN 43625, VDE 0670 part 4, VDE 0670 part 402 and with IEC 60282-1 (2005).

'A' range is suitable for indoor use.

'T' range is suitable for indoor and outdoor use .

Time-Current Curves and Cut-Off Curves: see list page 120 and data on CD at the back of the catalogue.

Dimensions (mm):

Fuse Reference	A	C	D	Weight (Kg)
AFMSJ	442	79	76	4.5
AIMSJ	442	79	76	4.5
TDMEJ	442	54	51	2.5
THMEJ	442	67	64	3.7
TFMEJ	442	80	76	5.1
TXMEJ	442	91	88	5.9



Features and Benefits

- *Cool running, low watts loss and power dissipation* thanks to the M-effect ensuring high levels of substation utilisation
- *Silver elements* ensuring high conductivity and low power (revenue) loss
- *100% X-ray*, all our Medium Voltage fuse links are X-rayed ensuring the highest possible standards are maintained

Typical Applications

- Primary side transformer protection
- Used in fuse switch combination unit
- Used in fuse bases
- Used in fuse switches

EJ Outline



SJ Outline

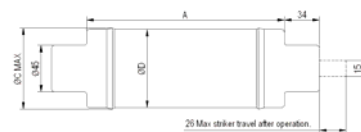

Part Numbers

Part Number	Rated Current I_n (A)	Breaking Capacity I_1 (kA)	Minimum Breaking Current I_3 (A)	Cold Resistance & Watts Loss in Free Air		Joule Integral (I^2t)		Length mm	Diameter mm	Weight kg
				mΩ	W	Minimum Pre-Arcing	Maximum Operating			
24AFMSJ50	50	20	137	29.5	102	1.8×10^3	2.9×10^4	442	76	4.5
24AFMSJ63	63	20	125	23.6	130	3.2×10^3	4.5×10^4	442	76	4.5
24AIMSJ71	71	20	176	15.1	106	6.3×10^3	8.5×10^4	442	76	4.5
24TDMEJ6.3	6.3	50	23	444	20	9.8×10^1	1.0×10^3	442	51	2.5
24TDMEJ10	10	50	34	262	32	2.8×10^2	2.3×10^3	442	51	2.5
24TDMEJ16	16	50	56	109	34	2.6×10^2	3.9×10^3	442	51	2.5
24TDMEJ20	20	50	73	78.2	38	5.2×10^2	5.4×10^3	442	51	2.5
24TDMEJ25	25	50	92	62.4	49	8.1×10^2	8.4×10^3	442	51	2.5
24TDMEJ31.5	31.5	50	92	46.8	59	1.4×10^3	1.5×10^4	442	51	2.5
24TDMEJ40	40	50	118	34.3	79	2.4×10^3	2.5×10^4	442	51	2.5
24TDMEJ50	50	50	185	27.0	98	2.8×10^3	3.1×10^4	442	51	2.5
24THMEJ63	63	50	217	21.1	127	4.3×10^3	4.7×10^4	442	64	3.7
24TFMEJ80	80	50	265	15.7	153	7.9×10^3	9.1×10^4	442	76	5.1
24TFMEJ100**	100	63	430	18.0	400	2.8×10^4	9.4×10^4	442	76	5.1
24TXMEJ125**	125	40	760	11.0	340	9.7×10^4	3.5×10^5	442	88	5.9
24TXMEJ160**	160	31.5	900	9.60	515	1.3×10^5	5.0×10^5	442	88	5.9

* Not suitable for outdoor use

** Not compliant with VDE 0670 part 402

36kV - 'T' Range Current Limiting Back-Up Fuse-Links

Specifications

Description: A range of medium voltage DIN fuse links, complete with sealed striker, suitable for transformer protection. The fuse links can be used even when there is no secondary low voltage protection, provided they are used with fuse switches fitted with instantaneous striker tripping.

Ratings:

Rated Voltage: 18 - 36kV
 Rated Current: 3.15 - 63A
 Breaking Capacity: 20 - 35.5kA

Agency Information: Comply with DIN Dimensional standard DIN 43625, VDE 0670 part 4, VDE 0670 part 402 and with IEC 60282-1 (2005). Suitable for indoor and outdoor use.

Time-Current Curves and Cut-Off Curves: see list page 120 and data on CD at the back of the catalogue.

Dimensions (mm):

Fuse Reference	A	C	D	Weight (Kg)
TDQSJ	537	54	51	2.9
TFQSJ	537	80	76	6.0
TXQEJ	537	88	88	6.5



Features and Benefits

- *Cool running, low watts loss and power dissipation* thanks to the M-effect ensuring high levels of substation utilisation
- *Silver elements* ensuring high conductivity and low power (revenue) loss
- *100% X-ray*, all our Medium Voltage fuse links are X-rayed ensuring the highest possible standards are maintained

Typical Applications

- Primary side transformer protection
- Used in fuse switch combination unit
- Used in fuse bases
- Used in fuse switches

EJ Outline

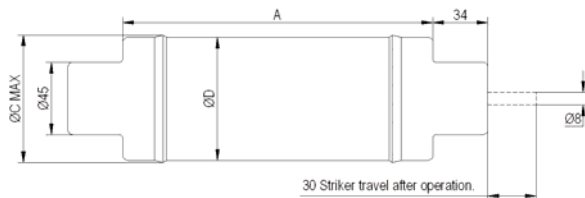

SJ Outline

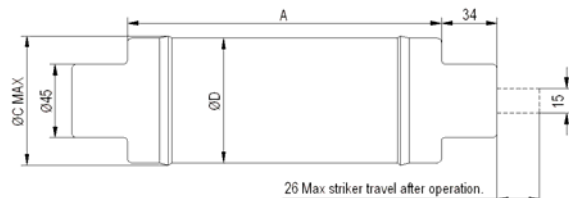

Part Numbers

Part Number	Rated Current I_n (A)	Breaking Capacity I_1 (kA)	Minimum Breaking Current I_3 (A)	Cold Resistance & Watts Loss in Free Air		Joule Integral (I^2t)		Length mm	Diameter mm	Weight kg
				mΩ	W	Minimum Pre-Arcing	Maximum Operating			
36TDQSJ3.15	3.15	20	23	1455	18	2.0×10^1	2.4×10^2	537	51	2.9
36TDQSJ6.3	6.3	35.5	23	684	34	1.0×10^2	1.2×10^3	537	51	2.9
36TDQSJ10	10	35.5	35	402	44	3.1×10^2	3.6×10^3	537	51	2.9
36TDQSJ16	16	35.5	70	165	52	4.6×10^2	5.1×10^3	537	51	2.9
36TDQSJ20	20	35.5	98	117	62	8.9×10^2	8.2×10^4	537	51	2.9
36TDQSJ25	25	35.5	112	98.0	85	1.2×10^3	1.5×10^4	537	51	2.9
36TFQSJ31.5	31.5	35.5	116	73.4	96	2.1×10^3	2.3×10^4	537	51	6.0
36TFQSJ40	40	35.5	178	52.4	116	4.1×10^3	3.9×10^4	537	76	6.0
36TFQSJ50	50	35.5	255	36.8	133	8.3×10^3	8.1×10^4	537	76	6.0
36TXQEJ63*	63	20	360	35.0	271	1.1×10^4	6.2×10^4	537	88	6.5

* Not compliant with VDE 0670 part 402

Striker Force Diagrams

E = Spring Striker 80N to DIN IEC 60282-1 Designation 'Medium'

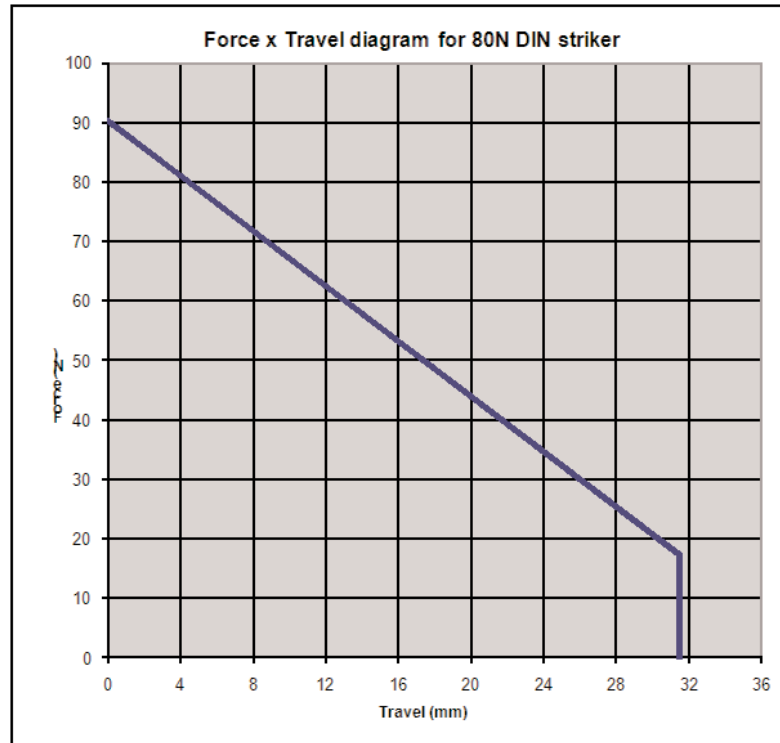

S = Spring Striker 50N to DIN 43625 and IEC 60282-1 Designation 'Medium'

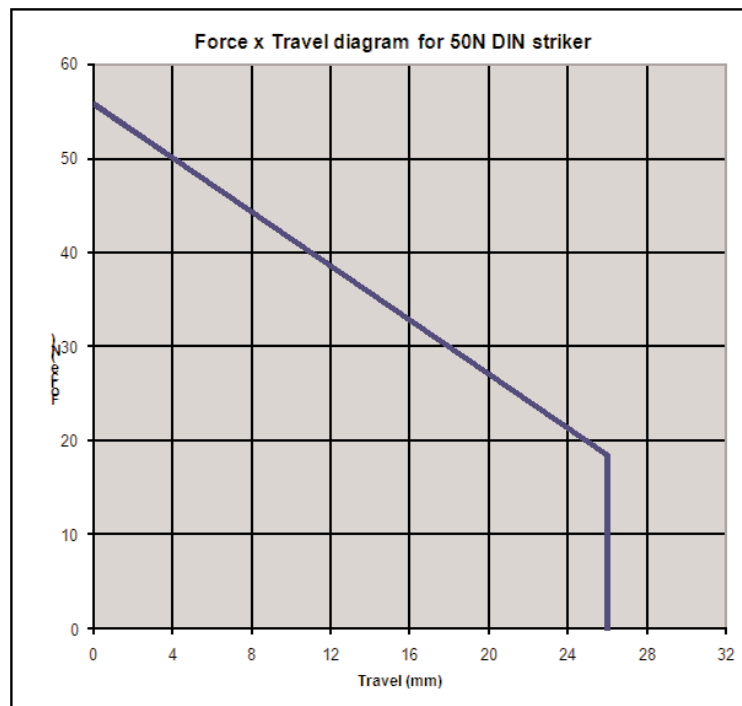

Medium Voltage Motor Fuse Links



Introduction to Motor Fuse Links 26 - 27

British Standard

 3.6kV 28 - 29

 7.2kV 30

DIN

 3.6kV 31

 7.2kV 32

USA

 2.75kV 33

 5.5kV 34

Introduction to Medium Voltage Motor Fuse Links

- Motor Fuse Links comply with IEC 60282-1, IEC 644 and BS 5907.
- Available in DIN 43625 and BS 2692 dimensions.
- Sold in a wide range of ratings from:
 - 3.6kV - 5 to 450A
 - 7.2kV - 5 to 355A
- North American dimensioned products also available, 2R to 24R ratings.



Cooper Bussmann Motor Fuse Links

Cooper Bussmann range of motor fuse links are designed to meet the specific requirements necessary for motor protection. During the starting cycle of direct on-line motors, the fuse elements will reach a considerably higher temperature than during normal operation; this is due to the high amount of current the motor will draw as it starts, typically, 6 times its normal load current value. This results in expansion and contraction of the fuse elements and could cause premature operation of the fuse link. Cooper Bussmann motor fuse links encompass an advanced design to minimise this effect. This therefore, negates the need to over specify the fuse rating due to high values of motor starting current.

Cooper Bussmann fuse links operate extremely quickly under heavy fault currents, resulting from the time-current characteristic. Low power dissipation ensures low temperature rise, important in multi-tier starters for example. Switching (Arc) voltages are lower than permitted values, therefore, 5.5kV fuse links are also suitable for 4.8kV and 2.4kV circuits.

Application

Fuse links provide short-circuit protection in motor circuits to both the motor starter and cables from the starter to the motor. Overload protection is provided by the motor starter, generally by an overload relay and contactor. Combination striker tripping may also form part of the associated equipment which houses the fuse links and motor starters.

Application Procedure

For any motor the fuse current rating is determined by magnitude and duration of starting current, except in a few situations where the starting currents are very light.

Introduction to Medium Voltage Motor Fuse Links

Direct-on-Line Starting

In the absence of specific information, the starting current can usually be taken to be six times the motor's full load current. The starting time will depend on the type of the drive but will be approximately as follows:

Pump motors - 6 seconds

Mill motors - 10 to 15 seconds

Fan motors - 60 seconds

These are average values and the appropriate figures for starting current and starting time for actual installation should be obtained wherever possible.

Multiply the starting current by 1.7 and using this value of current and the starting time, (it is recommended that a minimum time of five seconds be adopted), plot this point on the time-current characteristics of the fuse link. The correct current rating of the fuse link is then chosen as being the one immediately to the right of the point plotted. The chosen fuse link must also have a current rating of at least 1.3 times the full load current of the associated motor.

The rating chosen will be adequate for normal applications where the associated motor is not started more than twice in a given period of one hour.

For applications using more frequent starting duties, a greater derating factor must be applied as shown below:

- Maximum 2 starts per hour - Derating factor 1.7
- Maximum 4 starts per hour - Derating factor 1.9
- Maximum 8 starts per hour - Derating factor 2.1
- Maximum 16 starts per hour - Derating factor 2.4

Assisted Starting

A similar method of fuse selection may be used as for direct-on-line starting (see above), but it must be noted that the normal running current of the motor is likely to be closer in value to the nominal current rating of the fuse link than for direct-on-line applications.

The rating of fuse link chosen will need to be appreciably greater than the motor running current to allow for restricted cooling inside control gear cubicles, particularly where multi-tier starters are involved. In case of doubt refer to Cooper Bussmann for further guidance.

Notes

For applications involving more frequent starting duties than 16 times per hour or where unusual duty cycles are involved, consult Cooper Bussmann application engineers for advice: buletechnical@cooperindustries.com or 00 44 (0) 1509 882 699.

3.6kV - Motor Fuse Links to British Standard Dimensions

Specifications

Description: Motor fuse links providing short circuit protection in motor circuits to both the motor starter and cables from the starter to the motor.

Ratings:

Rated Voltage: 3.6kV
 Rated Current: 5 - 450A
 Breaking Capacity: 50kA

Agency Information: BS 2692-1

Time-Current Curves and Cut-Off Curves: see list page 120 and data on CD at the back of the catalogue.

Dimensions (mm):

Tag Type '6' - BS 2692 Standard

Fuse Link Type	A	B	C	D	E	F	G	H	J
+WJON6	257	235	192	36	9.5	13	25	23	2.4
WDO*H6	261	235	192	51	10.5	13	25	29	2.6
WFO*H6	261	235	192	76	10.5	20	64	42	2.6

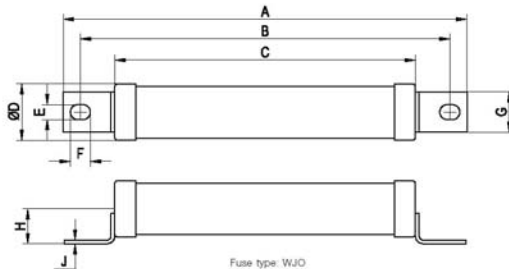

Features and Benefits

- Cool running, low watts loss and power dissipation thanks to the M-effect.
- Silver elements ensuring high conductivity and low power (revenue) loss
- 100% X-ray, all our Medium Voltage fuse links are X-rayed ensuring the highest possible standards are maintained
- Allows motor start current to pass on without degradation of fuse link

Typical Applications

- Motor protection

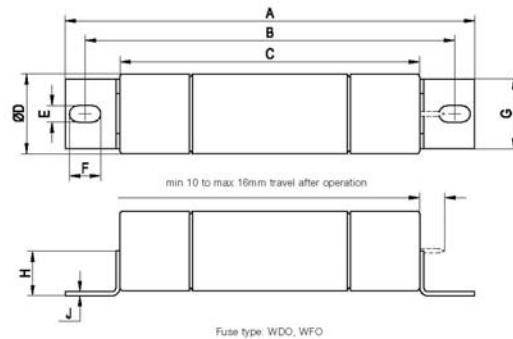

Tag Type 'O' - BS 2692 Standard

Fuse Link Type	A	B	C	D
WDFHO	337	305	254	51
WFFHO	337	305	254	76
WKFHO	337	305	254	76
WFGHO	442	410	359	76
WKGHO	442	410	359	76

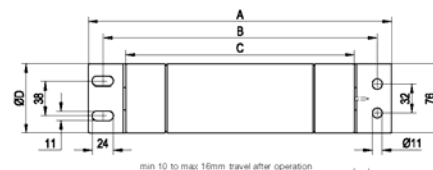
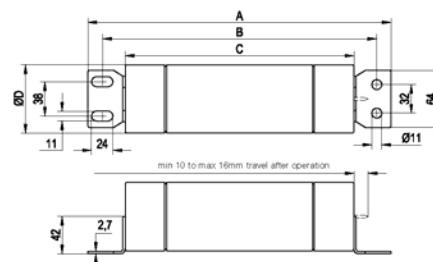

Triple barrel fuse link
 (3rd barrel shown dotted) with 03 tags.

Double barrel fuse link with 02 tags
 shown in full line.

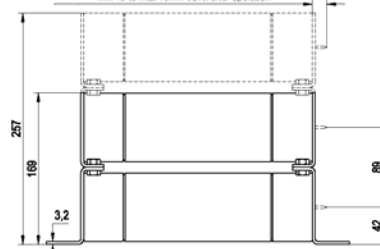

3.6kV - Motor Fuse Links to British Standard Dimensions

Part Numbers

Part Number	Rated Current I_n (A)	Breaking Capacity I_1 (kA)	Minimum Breaking Current I_3 (A)	Cold Resistance & Watts Loss in Free Air		Joule Integral (I^2t)		Length mm	Diameter mm	Weight kg
				m Ω	W	Minimum Pre-Arcing	Maximum Operating			
Tag Type '6' - BS 2692 Standard										
3.6WJON65	5	50	13	148	5	2×10^1	1.6×10^3	192	35	0.54
3.6WJON66.3	6.3	50	24	56.3	8	1.6×10^2	1.3×10^3	192	35	0.54
3.6WJON610	10	50	24	56.3	8	1.6×10^2	1.3×10^3	192	35	0.54
3.6WJON616	16	50	56	33.1	12	1.7×10^2	1.4×10^3	192	35	0.54
3.6WJON620	20	50	56	22.1	12	3.9×10^2	3.2×10^3	192	35	0.54
3.6WJON625	25	50	70	17.7	15	6.1×10^2	4.9×10^3	192	35	0.54
3.6WJON631.5	31.5	50	112	10.1	14	1.2×10^3	9.8×10^3	192	35	0.54
3.6WJON640	40	50	112	7.54	17	2.1×10^3	1.7×10^4	192	35	0.54
3.6WJON650	50	50	140	6.03	21	3.2×10^3	2.6×10^4	192	35	0.54
3.6WDOH650	50	50	180	5.36	20	1.8×10^3	2.4×10^4	192	51	1.1
3.6WDOH663	63	50	225	3.68	21	3.8×10^3	4.5×10^4	192	51	1.1
3.6WDOH680	80	50	288	2.88	27	6.3×10^3	8.0×10^4	192	51	1.1
3.6WDOH6100	100	50	360	2.16	31	9.8×10^3	1.1×10^5	192	51	1.1
3.6WDOH6125	125	50	450	1.73	39	1.5×10^4	2.2×10^5	192	51	1.1
3.6WFOH6160	160	50	600	1.28	47	3.1×10^4	6.2×10^5	192	76	2.1
3.6WFOH6200	200	50	600	0.938	52	5.7×10^4	1.1×10^6	192	76	2.1
Tag Type 'O' - BS 2692 Standard										
3.6WDFHO50	50	50	152	6.61	21	1.8×10^3	2.4×10^4	254	51	1.46
3.6WDFHO63	63	50	171	5.03	28	3.1×10^3	4.5×10^4	254	51	1.46
3.6WDFHO80	80	50	190	3.52	31	6.3×10^3	8×10^4	254	51	1.46
3.6WDFHO100	100	50	190	2.87	39	9.5×10^3	1.2×10^5	254	51	1.46
3.6WDFHO125	125	50	190	2.44	53	1.3×10^4	1.8×10^5	254	51	1.46
3.6WFFHO160	160	50	300	1.53	54	3.4×10^4	4.1×10^5	254	76	3.2
3.6WFFHO200	200	50	300	1.24	67	5.1×10^4	7.2×10^5	254	76	3.2
3.6WKFHO250	250	50	520	0.653	57	1.8×10^5	2.4×10^6	254	76	3.2
3.6WKFHO315	315	50	650	0.435	60	4.1×10^5	5×10^6	254	76	3.2
3.6WKFHO355	355	50	820	0.345	59	6.4×10^5	7×10^6	254	76	3.2
3.6WKFHO400	400	50	820	0.345	76	6.4×10^5	7×10^6	254	76	3.2
3.6WKFHGO31.5	31.5	50	151	18.4	25	4.5×10^2	6×10^3	359	76	4.1
3.6WFGHO40	40	50	151	13.9	31	8×10^2	1.2×10^4	359	76	4.1
3.6WFGHO50	50	50	151	9.24	32	1.8×10^3	2.2×10^4	359	76	4.1
3.6WFGHO63	63	50	151	6.93	38	3.2×10^3	4.5×10^4	359	76	4.1
3.6WFGHO80	80	50	170	5.47	48	5.1×10^3	7.5×10^4	359	76	4.1
3.6WFGHO100	100	50	212	4.40	62	7.9×10^3	1.2×10^5	359	76	4.1
3.6WFGHO125	125	50	212	3.60	79	1.2×10^4	1.7×10^5	359	76	4.1
3.6WFGHO160	160	50	300	2.16	75	3.4×10^4	4.2×10^5	359	76	4.1
3.6WFGHO200	200	50	300	1.77	95	5.1×10^4	7×10^5	359	76	4.1
3.6WFGHO250	250	50	500	1.13	96	1.3×10^5	1.9×10^6	359	76	4.1
3.6WKGHO315	315	50	852	0.646	89	4.5×10^5	6×10^6	359	76	3.9
3.6WKGHO355	355	50	852	0.512	90	6.4×10^5	8.5×10^6	359	76	3.9
3.6WKGHO400	400	50	960	0.454	100	8.2×10^5	1.1×10^7	359	76	3.9
3.6WKGHO450	450	50	1150	0.379	108	1.2×10^6	1.5×10^7	359	76	3.9

Higher ratings than those listed above can be obtained by using fuse links connected in parallel. Special fixing arrangements for connecting up to three fuse links in parallel are available. Please contact Cooper Bussmann application engineers buletechnical@cooperindustries.com for more details. The code designations for these arrangements are given in "How to order" page 7 and 8.

7.2kV - Motor Fuse Links to British Standard Dimensions

Specifications

Description: Motor fuse links providing short circuit protection in motor circuits to both the motor starter and cables from the starter to the motor.

Ratings:

Rated Voltage: 7.2kV
 Rated Current: 25 - 315A
 Breaking Capacity: 40kA

Agency Information: Comply with BS 2692-1.

Time-Current Curves and Cut-Off Curves: see list page 120 and data on CD at the back of the catalogue.

Dimensions

Fuse Link Type	A	B	C	D
WFNHO	486	454	403	76
WKNHO	486	454	403	76

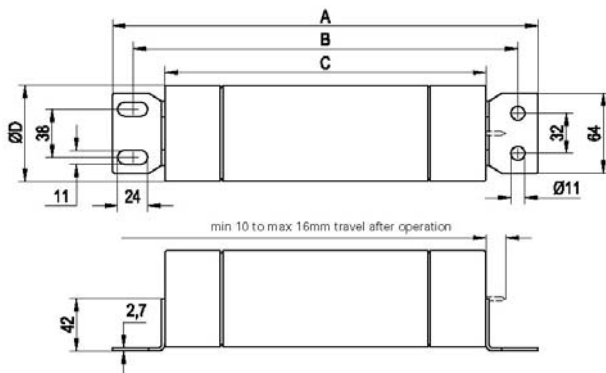

Triple barrel fuse link (3rd barrel shown dotted) with 03 tags.

Double barrel fuse link with 02 tags shown in full line.



Features and Benefits

- *Cool running, low watts loss and power dissipation* thanks to the M-effect.
- *Silver elements* ensuring high conductivity and low power (revenue) loss
- *100% X-ray*, all our Medium Voltage fuse links are X-rayed ensuring the highest possible standards are maintained
- Allows motor start current to pass on without degradation of fuse link

Typical Applications

- Motor protection

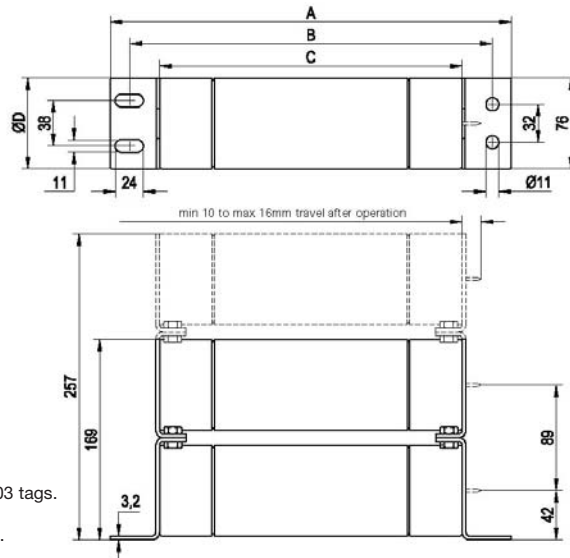

Part Numbers

Part Number	Rated Current I_n (A)	Breaking Capacity I_1 (kA)	Minimum Breaking Current I_3 (A)	Cold Resistance & Watts Loss in Free Air		Joule Integral (I^2t)		Length mm	Diameter mm	Weight kg
				m Ω	W	Minimum Pre-Arcing	Maximum Operating			
7.2WFNHO25	25	40	84	38.7	34	1.4×10^2	2.1×10^3	403	76	4.4
7.2WFNHO31.5	31.5	40	96	25.5	35	3.1×10^2	4.7×10^3	403	76	4.4
7.2WFNHO40	40	40	107	18.2	40	6.1×10^2	8.0×10^3	403	76	4.4
7.2WFNHO50	50	40	122	13.3	46	1.2×10^3	1.5×10^4	403	76	4.4
7.2WFNHO63	63	40	133	10.4	56	1.9×10^3	3.0×10^4	403	76	4.4
7.2WFNHO80	80	40	133	7.30	65	3.8×10^3	5.8×10^4	403	76	4.4
7.2WFNHO100	100	40	262	4.92	69	9.8×10^3	1.3×10^5	403	76	4.4
7.2WFNHO125	125	40	300	2.94	63	2.4×10^4	2.4×10^5	403	76	4.4
7.2WFNHO160	160	40	337	2.05	72	5.0×10^4	7.0×10^5	403	76	4.4
7.2WKNHO200	200	40	500	1.63	90	8.8×10^4	1.3×10^6	403	76	4.4
7.2WKNHO224	224	40	500	1.44	98	1.1×10^5	1.6×10^6	403	76	4.4
7.2WKNHO250	250	40	960	1.11	105	2.2×10^5	1.6×10^6	403	76	4.4
7.2WKNHO315	315	40	960	0.779	107	4.5×10^5	3.1×10^6	403	76	4.4

Higher ratings than those listed above can be obtained by using fuse links connected in parallel. Special fixing arrangements for connecting up to three fuse links in parallel are available. Please contact Cooper Bussmann application engineers buletechnical@cooperindustries.com for more details. The code designations for these arrangements are given in "How to order" page 7 and 8.

3.6kV - Motor Fuse Links to DIN Standard Dimensions

Specifications

Description: Motor fuse links providing short circuit protection in motor circuits to both the motor starter and cables from the starter to the motor.

Ratings:

Rated Voltage: 3.6kV
 Rated Current: 50 - 400A
 Breaking Capacity: 50kA

Agency Information: Comply with IEC 60282-1, VDE 0670 part 4 and DIN Dimensional standard DIN 43625.

Time-Current Curves and Cut-Off Curves: see list page 120 and data on CD at the back of the catalogue.

Dimensions (mm):

Fuse link reference	Length (A) mm	Diameter (D) mm	Weight Kg
WDOS	192	51	1.1
WFOS	192	76	2.1
WDLS	292	51	1.63
WFLS	292	76	3.16
WKLS	292	76	3.16

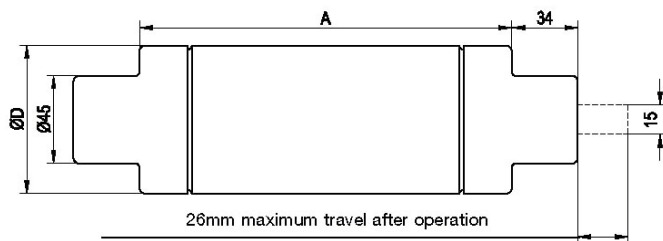

Features and Benefits

- Cool running, low watts loss and power dissipation thanks to the M-effect.
- Silver elements ensuring high conductivity and low power (revenue) loss
- 100% X-ray, all our Medium Voltage fuse links are X-rayed ensuring the highest possible standards are maintained
- Allows motor start current to pass on without degradation of fuse link

Typical Applications

- Motor protection

Part Numbers

Part Number	Rated Current I_n (A)	Breaking Capacity I_1 (kA)	Minimum Breaking Current I_3 (A)	Cold Resistance & Watts Loss in Free Air		Joule Integral (I^2t)		Length mm	Diameter mm	Weight kg
				m Ω	W	Minimum Pre-Arcing	Maximum Operating			
3.6WDOSJ50	50	50	180	5.36	20	1.8×10^3	2.4×10^4	192	51	1.1
3.6WDOSJ63	63	50	225	3.68	21	3.8×10^3	4.5×10^4	192	51	1.1
3.6WDOSJ80	80	50	288	2.88	27	6.3×10^3	8.0×10^4	192	51	1.1
3.6WDOSJ100	100	50	360	2.16	31	9.8×10^3	1.1×10^5	192	51	1.1
3.6WDOSJ125	125	50	450	1.73	39	1.5×10^4	2.2×10^5	192	51	1.1
3.6WFOSJ160	160	50	600	1.28	47	3.1×10^4	6.2×10^5	192	76	2.1
3.6WFOSJ200	200	50	600	0.938	52	5.7×10^4	1.1×10^6	192	76	2.1
3.6WDLSJ50	50	50	152	7.73	27	1.8×10^3	2.4×10^4	292	51	1.63
3.6WDLSJ63	63	50	171	5.9	32	3.1×10^3	4.5×10^4	292	51	1.63
3.6WDLSJ80	80	50	190	4.12	37	6.3×10^3	8.0×10^4	292	51	1.63
3.6WDLSJ100	100	50	190	3.38	46	9.5×10^3	1.2×10^5	292	51	1.63
3.6WDLSJ125	125	50	190	2.85	61	1.3×10^4	1.8×10^5	292	51	1.63
3.6WFLSJ160	160	50	300	1.74	61	3.4×10^4	4.1×10^5	292	76	3.16
3.6WFLSJ200	200	50	300	1.42	80	5.1×10^4	7.2×10^5	292	76	3.16
3.6WKLSJ250	250	50	820	0.741	67	1.9×10^5	2.4×10^6	292	76	3.16
3.6WKLSJ315	315	50	820	0.507	69	4.0×10^5	5.0×10^6	292	76	3.16
3.6WKLSJ400	400	50	820	0.401	90	6.4×10^5	7.0×10^6	292	76	3.16

7.2kV - Motor Fuse Links to DIN Standard Dimensions

Specifications

Description: Motor fuse links providing short circuit protection in motor circuits to both the motor starter and cables from the starter to the motor.

Ratings:

Rated Voltage: 7.2kV
 Rated Current: 25 - 355A
 Breaking Capacity: 63kA

Agency Information: Comply with IEC 60282-1, VDE 0670 part 4 and DIN Dimensional standard DIN 43625.

Time-Current Curves and Cut-Off Curves: see list page 120 and data on CD at the back of the catalogue.

Dimensions (mm):

Fuse link reference	Length (A) mm	Diameter (D) mm	Weight Kg
WFMS	442	76	5.2
WKMS	442	76	5.2

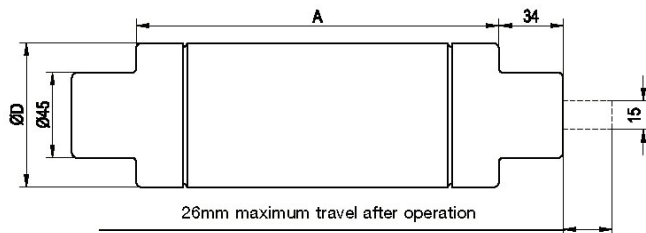

Features and Benefits

- *Cool running, low watts loss and power dissipation* thanks to the M-effect.
- *Silver elements* ensuring high conductivity and low power (revenue) loss
- *100% X-ray*, all our Medium Voltage fuse links are X-rayed ensuring the highest possible standards are maintained
- Allows motor start current to pass on without degradation of fuse link

Typical Applications

- Motor protection

Part Numbers

Part Number	Rated Current I_n (A)	Breaking Capacity I_1 (kA)	Minimum Breaking Current I_3 (A)	Cold Resistance & Watts Loss in Free Air		Joule Integral (I^2t)		Length mm	Diameter mm	Weight kg
				mΩ	W	Minimum Pre-Arcing	Maximum Operating			
7.2WFMSJ25	25	63	84	33.9	33	1.4×10^2	2.1×10^3	442	76	5.2
7.2WFMSJ31.5	31.5	63	96	25.4	40	3.1×10^2	4.7×10^3	442	76	5.2
7.2WFMSJ40	40	63	107	17.8	56	6.1×10^2	8.0×10^3	442	76	5.2
7.2WFMSJ50	50	63	122	14.8	53	1.2×10^3	1.5×10^4	442	76	5.2
7.2WFMSJ63	63	63	133	11.6	61	1.9×10^3	3.0×10^4	442	76	5.2
7.2WFMSJ80	80	63	133	8.12	72	3.8×10^3	5.8×10^4	442	76	5.2
7.2WFMSJ100	100	63	262	5.33	74	9.8×10^3	1.3×10^5	442	76	5.2
7.2WFMSJ125	125	63	300	3.19	70	2.4×10^4	2.4×10^5	442	76	5.2
7.2WFMSJ160	160	63	337	2.23	79	5.0×10^4	7.0×10^5	442	76	5.2
7.2WKMSJ200	200	63	500	1.79	99	8.8×10^4	1.3×10^6	442	76	5.2
7.2WKMSJ224	224	63	500	1.59	100	1.1×10^5	1.6×10^6	442	76	5.2
7.2WKMSJ250	250	63	960	1.23	107	2.2×10^5	1.6×10^6	442	76	5.2
7.2WKMSJ315	315	63	960	0.869	120	4.5×10^5	3.1×10^6	442	76	5.2
7.2WKMSJ355	355	63	1000	0.724	125	6.4×10^5	3.9×10^6	442	76	5.2

2.75kV - Motor Fuse Links to USA Dimensions

Specifications

Description: R-rated medium voltage current limiting fuse links for motor protection.

Ratings:

Rated Voltage: 2.75kV
 Rated Current: 2 - 24R
 Breaking Capacity: 60kA

Agency Information: IEEE standards

Dimensions (mm):

Fuse link reference	Length mm	Diameter mm	Weight Kg
VFRHA	276	76	2.5
VKRHA	276	76	2.5
VKRHK	276	76	5.2



Features and Benefits

- *Cool running, low watts loss and power dissipation* thanks to the M-effect.
- *Silver elements* ensuring high conductivity and low power (revenue) loss
- *100% X-ray*, all our Medium Voltage fuse links are X-rayed ensuring the highest possible standards are maintained
- Allows motor start current to pass on without degradation of fuse link

Typical Applications

- Motor protection

A Tags (ferrule)

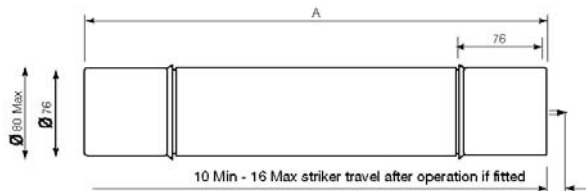

K Tags (double barrel fuse links)

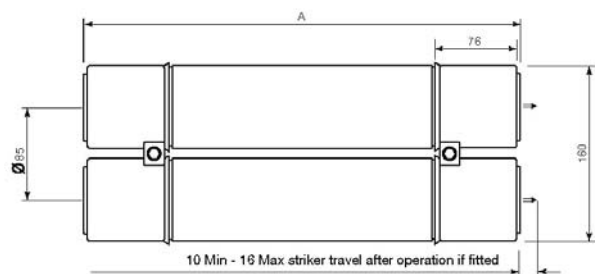

Part Numbers

Part Number	Breaking Capacity I ₁ (kA)	Minimum Breaking Current I ₃ (A)	Cold Resistance & Watts Loss in Free Air		Joule Integral (I ² t)		Length mm	Diameter mm	Weight kg
			mΩ	W	Minimum Pre-Arcing	Maximum Operating			
2.75VFRHA2R	60	180	6.15	52	8.1 x 10 ³	2.8 x 10 ⁴	276	76	2.5
2.75VFRHA3R	60	229	4.04	57	1.9 x 10 ⁴	7.5 x 10 ⁴	276	76	2.5
2.75VFRHA4R	60	257	2.69	62	4.2 x 10 ⁴	1.4 x 10 ⁵	276	76	2.5
2.75VFRHA6R	60	525	1.62	65	3.9 x 10 ⁴	3.4 x 10 ⁵	276	76	2.5
2.75VKRHA9R	60	500	1.15	70	8.8 x 10 ⁴	8.4 x 10 ⁵	276	76	2.5
2.75VKRHA12R	60	500	1.03	80	1.1 x 10 ⁵	1.2 x 10 ⁶	276	76	2.5
2.75VKRHK18R	60	500	0.577	140	3.5 x 10 ⁵	3.2 x 10 ⁶	276	76	5.2
2.75VKRHK24R	60	500	0.514	156	4.5 x 10 ⁵	5.5 x 10 ⁶	276	76	5.2

5.5kV - Motor Fuse Links to USA Dimensions

Specifications

Description: R-rated medium voltage current limiting fuse links for motor protection.

Ratings:

Rated Voltage: 5.5kV
 Rated Current: 2 - 24R
 Breaking Capacity: 60kA

Agency Information: IEEE standards

Dimensions (mm):

Fuse link reference	Length mm	Diameter mm	Weight Kg
VFNHA	403	76	3.8
VKNHA	403	76	3.8
VKNHK	403	76	7.8



Features and Benefits

- *Cool running, low watts loss and power dissipation* thanks to the M-effect ensuring high levels of substation utilisation
- *Silver elements* ensuring high conductivity and low power (revenue) loss
- *100% X-ray*, all our Medium Voltage fuse links are X-rayed ensuring the highest possible standards are maintained

Typical Applications

- Motor protection

A Tags (ferrule)

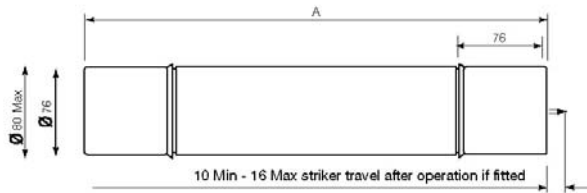

K Tags (double barrel fuse links)

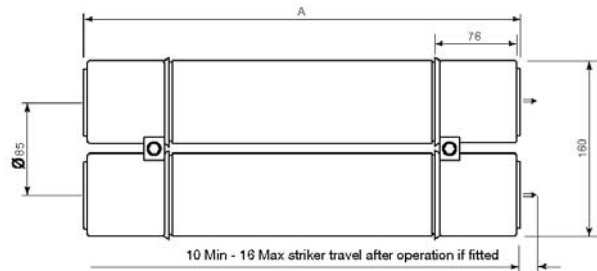

Part Numbers

Part Number	Breaking Capacity I ₁ (kA)	Minimum Breaking Current I ₃ (A)	Cold Resistance & Watts Loss in Free Air		Joule Integral (I ² t)		Length mm	Diameter mm	Weight kg
			mΩ	W	Minimum Pre-Arcing	Maximum Operating			
5.5VFNHA2R	60	180	8.35	70	8.1 x 10 ³	2.8 x 10 ⁴	403	76	3.8
5.5VFNHA3R	60	229	5.48	77	1.9 x 10 ⁴	7.9 x 10 ⁴	403	76	3.8
5.5VFNHA4R	60	257	3.65	85	4.2 x 10 ⁴	1.6 x 10 ⁵	403	76	3.8
5.5VFNHA6R	60	525	2.31	91	3.9 x 10 ⁴	3.6 x 10 ⁵	403	76	3.8
5.5VKNHA9R	60	500	1.63	99	8.8 x 10 ⁴	8.8 x 10 ⁵	403	76	3.8
5.5VKNHA12R	60	500	1.45	110	1.1 x 10 ⁵	1.3 x 10 ⁶	403	76	3.8
5.5VKNHK18R	60	500	0.815	198	3.5 x 10 ⁵	3.4 x 10 ⁶	403	76	7.8
5.5VKNHK24R	60	500	0.725	220	4.5 x 10 ⁵	5.8 x 10 ⁶	403	76	7.8

Medium Voltage and Auxiliary Transformer Fuse Links



Introduction to Medium Voltage and Auxiliary Transformer Fuse Links..36

Medium Voltage and Auxiliary Transformer

1.1kV.....	37
3.6kV.....	38
5.5kV - Type E.....	39
7.2kV.....	40
12kV.....	41
15.5kV.....	42
17.5kV.....	43
24kV.....	44
36kV.....	45

Type CAV

3.6kV.....	46
5.5kV.....	47
7.2kV.....	48
12kV.....	49
15.5kV.....	50
17.5kV.....	51
24kV.....	52
36kV.....	53
38kV.....	54

Introduction to Medium Voltage and Auxiliary Transformer Fuse Links

- British Standard Voltage and Auxiliary Transformer (VT) fuse links.
- A range of voltage transformer primary fuse links to BS 2692-1 and IEC 60282-1.
- Wide range of ratings from 1kV to 36kV.
- 3.15 Amp industry standard current ratings.
- CAV range with ratings from 3.6kV to 38kV.



Cooper Bussmann Voltage and Auxiliary Transformer Fuse Links

Cooper Bussmann manufactures a wide range of voltage transformer (VT) fuse links. In North America they are referred to as Potential Transformer fuse links. These fuse links are designed for use in the primary side of voltage transformers to provide system isolation in the event of faults occurring in the transformer circuit.

Voltage transformer fuse links have a preferred current rating of 3.15A. Experience has shown that there is a risk of spurious operation by transient overcurrents where lower current ratings are used. In addition, in order to minimise the risk of deterioration of the fine fuse elements caused by corona, it is desirable to mount the fuse links so that the earthed metal is not in the immediate vicinity of the part of the barrel between the ferrules.

Higher current and 'E' ratings are available for special applications, including auxiliary transformers.

A range of VT fuse links with a breaking capacity of 200kA for use at the output terminals of large turbo alternators can also be ordered. For further information, please contact Cooper Bussmann application engineers: buletechnical@cooperindustries.com.

Types prefixed 'A' or 'N' are suitable for use indoors in air only. Types prefixed 'O' may be used under oil.

Application

Small rated fuse links for protection of voltage and auxiliary transformers. Back-up protection up to 3.15A and voltages from 1.1kV to 36kV.

1.1kV - Voltage and Auxiliary Transformer Fuse Links

Specifications

Description: Voltage transformer fuse links

Ratings:

Rated Voltage: 1.1kV
 Rated Current: 2 - 6.3A
 Breaking Capacity: 50kA

Agency Information: Comply with BS 2692-1 and IEC 60282-1

Time-Current Curves and Cut-Off Curves: see list page 120 and data on CD at the back of the catalogue.

Dimensions (mm):

Fuse link reference	A (mm)	B (mm)	D (mm)
NBUN	86	17.5	25.4

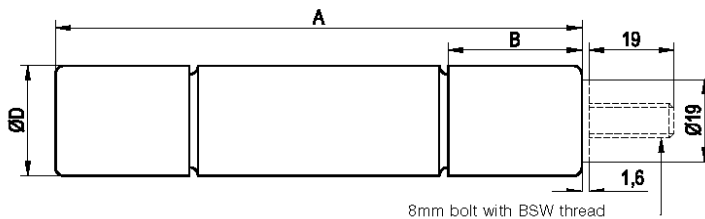

Ferrule fuse links tag type 'A' shown in full lines and '22': tag shown in dotted lines

Part Numbers

Part Number	Rated Current I_n (A)	Breaking Capacity I_1 (kA)	Cold Resistance $m\Omega$	Joule Integral (I^2t)		Length mm	Diameter mm	Weight kg
				Minimum Pre-Arcing	Maximum Operating			
1.1NBUN*2	2	50	0.145	6.3×10^0	1.8×10^1	86	25.4	0.12
1.1NBUN*3.15	3.15	50	0.107	1.2×10^1	3.4×10^1	86	25.4	0.12
1.1NBUN*6.3	6.3	50	0.065	3.2×10^1	9.2×10^1	86	25.4	0.12

* The last letter of the ordering code on these items is normally either "A" or "22", please refer to how to order page 7 and 8.

Features and Benefits

- *Cool running, low watts loss and power dissipation* thanks to the M-effect ensuring high levels of substation utilisation
- *Silver elements* ensuring high conductivity and low power (revenue) loss
- *100% X-ray*, all our Medium Voltage fuse links are X-rayed ensuring the highest possible standards are maintained

Typical Applications

- Protection of auxiliary transformers

3.6kV - Voltage and Auxiliary Transformer Fuse Links

Specifications

Description: Voltage transformer fuse links

Ratings:

Rated Voltage: 3.6kV
 Rated Current: 3.15 - 10A
 Breaking Capacity: 50kA

Agency Information: Comply with BS 2692-1 and IEC 60282-1

Time-Current Curves and Cut-Off Curves: see list page 120 and data on CD at the back of the catalogue.

Dimensions (mm):

Fuse link reference	A mm	B mm	D mm
ABWN	142	30	25.4
ABCN	195	30	25.4



Features and Benefits

- *Cool running, low watts loss and power dissipation* thanks to the M-effect ensuring high levels of substation utilisation
- *Silver elements* ensuring high conductivity and low power (revenue) loss
- *100% X-ray*, all our Medium Voltage fuse links are X-rayed ensuring the highest possible standards are maintained

Typical Applications

- Protection of auxiliary transformers

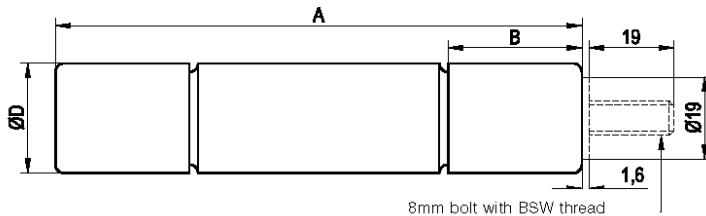

Ferrule fuse links tag type 'A' shown in full lines and '22': tag shown in dotted lines

Part Numbers

Part Number	Rated Current I_n (A)	Breaking Capacity I_1 (kA)	Cold Resistance $m\Omega$	Joule Integral (I^2t)		Length mm	Diameter mm	Weight kg
				Minimum Pre-Arcing	Maximum Operating			
3.6ABWN*3.15	3.15	50	0.358	6.3×10^0	1.8×10^1	142	25.4	0.19
3.6ABWN*6.3	6.3	50	0.120	4.8×10^1	3.1×10^2	142	25.4	0.19
3.6ABCN*3.15	3.15	50	0.358	6.3×10^0	1.8×10^1	195	25.4	0.245
3.6ABCN*6.3	6.3	50	0.120	4.8×10^1	3.1×10^2	195	25.4	0.245
3.6ABCN*10	10	50	0.080	1.1×10^2	7.0×10^2	195	25.4	0.245

* The last letter of the ordering code on these items is normally either "A" or "22", please refer to how to order page 7 and 8.

5.5kV - Type E Voltage Transformer Fuse Links

Specifications

Description: Voltage transformer fuse links

Ratings:

Rated Voltage: 5.5kV
 Rated Current: 0.5 - 5A
 Breaking Capacity: 50kA

Agency Information: Comply with BS 2692-1 and IEC 60282-1

Time-Current Curves and Cut-Off Curves: see list page 120 and data on CD at the back of the catalogue.

Dimensions (mm):

Fuse link reference	A mm	B mm	D mm
ABWNA	142	30	25.4
AMWNA	142	16	20.6

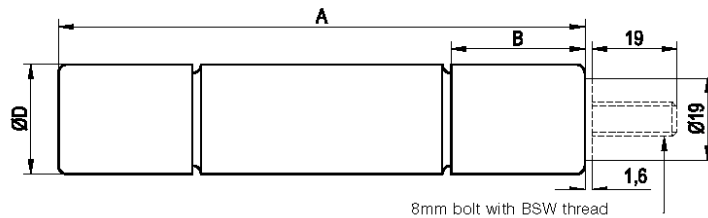

Ferrule fuse links tag type 'A' shown in full lines and '22': tag shown in dotted lines

Part Numbers

Part Number	Rated Current I_n (A)	Breaking Capacity I_1 (kA)	Cold Resistance $m\Omega$	Joule Integral (I^2t)		Length mm	Diameter mm	Weight kg
				Minimum Pre-Arcing	Maximum Operating			
5.5AMWNA0.5E	0.5	50	32.5	1.2×10^0	3.5×10^0	142	20.6	0.114
5.5AMWNA1E	1	50	16	5.0×10^0	1.4×10^1	142	20.6	0.114
5.5AMWNA2E	2	50	0.584	4.0×10^0	1.2×10^1	142	20.6	0.114
5.5AMWNA3E	3	50	0.32	1.8×10^1	1.1×10^2	142	20.6	0.114
5.5AMWNA4E	4	50	0.19	4.6×10^1	3.0×10^2	142	20.6	0.114
5.5AMWNA5E	5	50	0.147	7.9×10^1	5.1×10^2	142	20.6	0.114
5.5ABWNA0.5E	0.5	50	50.2	0.49×10^0	1.4×10^0	142	25.4	0.19
5.5ABWNA1E	1	50	25.1	2.0×10^0	5.7×10^0	142	25.4	0.19
5.5ABWNA2E	2	50	1.08	1.2×10^0	3.4×10^0	142	25.4	0.19
5.5ABWNA3E	3	50	0.469	6.3×10^0	1.8×10^1	142	25.4	0.19
5.5ABWNA5E	5	50	0.199	3.2×10^1	2.0×10^2	142	25.4	0.19



Features and Benefits

- *Cool running, low watts loss and power dissipation* thanks to the M-effect ensuring high levels of substation utilisation
- *Silver elements* ensuring high conductivity and low power (revenue) loss
- *100% X-ray*, all our Medium Voltage fuse links are X-rayed ensuring the highest possible standards are maintained

Typical Applications

- Protection of auxiliary transformers

7.2kV - Voltage and Auxiliary Transformer Fuse Links

Specifications

Description: Voltage transformer fuse links

Ratings:

Rated Voltage: 7.2kV
 Rated Current: 3.15 - 6.3A
 Breaking Capacity: 45kA

Agency Information: Comply with BS 2692-1 and IEC 60282-1

Time-Current Curves and Cut-Off Curves: see list page 120 and data on CD at the back of the catalogue.

Dimensions (mm):

Fuse link reference	A mm	B mm	D mm
ABWN*	142	30	25.4
ABCN*	195	30	25.4
AMWN	142	16	20.6
OBCN*	195	30	25.4
OBWN*	142	30	25.4



Features and Benefits

- *Cool running, low watts loss and power dissipation* thanks to the M-effect ensuring high levels of substation utilisation
- *Silver elements* ensuring high conductivity and low power (revenue) loss
- *100% X-ray*, all our Medium Voltage fuse links are X-rayed ensuring the highest possible standards are maintained

Typical Applications

- Protection of auxiliary transformers

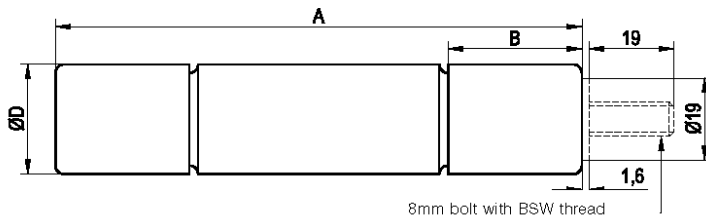

Ferrule fuse links tag type 'A' shown in full lines and '22': tag shown in dotted lines

Part Numbers

Part Number	Rated Current I_n (A)	Breaking Capacity I_1 (kA)	Cold Resistance $m\Omega$	Joule Integral (I^2t)		Length mm	Diameter mm	Weight kg
				Minimum Pre-Arcing	Maximum Operating			
7.2ABWN*3.15	3.15	45	0.614	6.3×10^0	4×10^1	142	25.4	0.19
7.2ABWN*6.3	6.3	45	0.24	4.8×10^1	3.1×10^2	142	25.4	0.19
7.2ABCN*3.15	3.15	45	0.614	6.3×10^0	4×10^1	195	25.4	0.245
7.2ABCN*6.3	6.3	45	0.24	4.8×10^1	3.1×10^2	195	25.4	0.245
7.2AMWNA0.5E	0.5	50	47.5	0.2×10^0	1×10^0	142	20.6	0.19
7.2AMWNA1.0E	1	50	23.3	1.2×10^0	4.8×10^0	142	20.6	0.19
7.2AMWNA2.0E	2	50	1.37	1.7×10^0	8.8×10^0	142	20.6	0.19
7.2AMWNA3.0E	3	50	0.77	4×10^0	2.7×10^1	142	20.6	0.19
7.2AMWNA4.0E	4	50	0.428	1.2×10^1	5.1×10^1	142	20.6	0.19
7.2AMWNA5.0E	5	50	0.274	2.8×10^1	1.4×10^2	142	20.6	0.19
7.2OBCN*3.15	3.15	45	0.614	6.3×10^0	4×10^1	195	25.4	0.245
7.2OBCN*6.3	6.3	45	0.24	4.8×10^1	3.1×10^2	195	25.4	0.245
7.2OBWN*3.15	3.15	45	0.614	6.3×10^0	4×10^1	142	25.4	0.19
7.2OBWN*6.3	6.3	45	0.24	4.8×10^1	3.1×10^2	142	25.4	0.19

* The last letter of the ordering code on these items is normally either "A" or "22", please refer to how to order page 7 and 8.

12kV - Voltage and Auxiliary Transformer Fuse Links

Specifications

Description: Voltage transformer fuse links

Ratings:

Rated Voltage: 12kV
 Rated Current: 3.15A
 Breaking Capacity: 45kA

Agency Information: Comply with BS 2692-1 and IEC 60282-1

Time-Current Curves and Cut-Off Curves: see list page 120 and data on CD at the back of the catalogue.

Dimensions (mm):

Fuse link reference	A mm	B mm	D mm
ABCN*	195	30	25.4
OBCN*	195	30	25.4

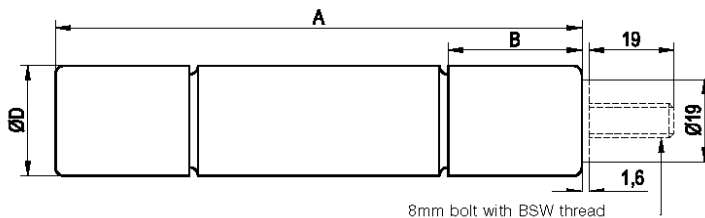

Ferrule fuse links tag type 'A' shown in full lines and '22': tag shown in dotted lines

Part Numbers

Part Number	Rated Current I_n (A)	Breaking Capacity I_1 (kA)	Cold Resistance $m\Omega$	Joule Integral (I^2t)		Length mm	Diameter mm	Weight kg
				Minimum Pre-Arcing	Maximum Operating			
12ABCN*3.15	3.15	45	1.21	6.3×10^0	1.8×10^1	195	25.4	0.245
12OBCN*3.15	3.15	45	1.21	6.3×10^0	1.8×10^1	195	25.4	0.245

* The last letter of the ordering code on these items is normally either "A" or "22", please refer to how to order page 7 and 8.



Features and Benefits

- *Cool running, low watts loss and power dissipation* thanks to the M-effect ensuring high levels of substation utilisation
- *Silver elements* ensuring high conductivity and low power (revenue) loss
- *100% X-ray*, all our Medium Voltage fuse links are X-rayed ensuring the highest possible standards are maintained

Typical Applications

- Protection of auxiliary transformers

15.5kV - Voltage and Auxiliary Transformer Fuse Links

Specifications

Description: Voltage transformer fuse links

Ratings:

Rated Voltage: 15.5kV
 Rated Current: 3.15A
 Breaking Capacity: 32kA

Agency Information: Comply with BS 2692 and IEC 60282-1

Time-Current Curves and Cut-Off Curves: see list page 120 and data on CD at the back of the catalogue.

Dimensions (mm):

Fuse link reference	A mm	B mm	D mm
ABFN*	254	30	25.4
OBFN*	254	30	25.4



Features and Benefits

- *Cool running, low watts loss and power dissipation* thanks to the M-effect ensuring high levels of substation utilisation
- *Silver elements* ensuring high conductivity and low power (revenue) loss
- *100% X-ray*, all our Medium Voltage fuse links are X-rayed ensuring the highest possible standards are maintained

Typical Applications

- Protection of auxiliary transformers

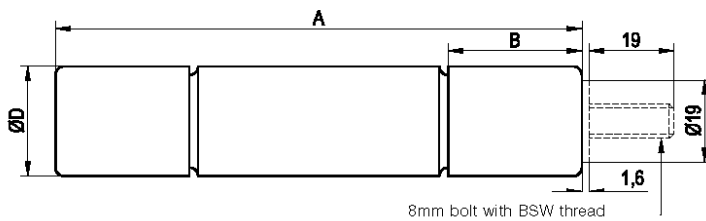

Ferrule fuse links tag type 'A' shown in full lines and '22': tag shown in dotted lines

Part Numbers

Part Number	Rated Current I_n (A)	Breaking Capacity I_1 (kA)	Cold Resistance $m\Omega$	Joule Integral (I^2t)		Length mm	Diameter mm	Weight kg
				Minimum Pre-Arcing	Maximum Operating			
15.5ABFN*3.15	3.15	32	1.24	6.3×10^0	4.0×10^1	254	25.4	0.31
15.5OBFN*3.15	3.15	32	1.24	6.3×10^0	4.0×10^1	254	25.4	0.31

* The last letter of the ordering code on these items is normally either "A" or "22", please refer to how to order page 7 and 8.

17.5kV - Voltage and Auxiliary Transformer Fuse Links

Specifications

Description: Voltage transformer fuse links

Ratings:

Rated Voltage: 17.5kV
 Rated Current: 3.15A
 Breaking Capacity: 35kA

Agency Information: Comply with BS 2692 and IEC 60282-1

Time-Current Curves and Cut-Off Curves: see list page 120 and data on CD at the back of the catalogue.

Dimensions (mm):

Fuse link reference	A mm	B mm	D mm
ABGN*	359	30	25.4
OBGN*	359	30	25.4



Features and Benefits

- *Cool running, low watts loss and power dissipation* thanks to the M-effect ensuring high levels of substation utilisation
- *Silver elements* ensuring high conductivity and low power (revenue) loss
- *100% X-ray*, all our Medium Voltage fuse links are X-rayed ensuring the highest possible standards are maintained

Typical Applications

- Protection of auxiliary transformers

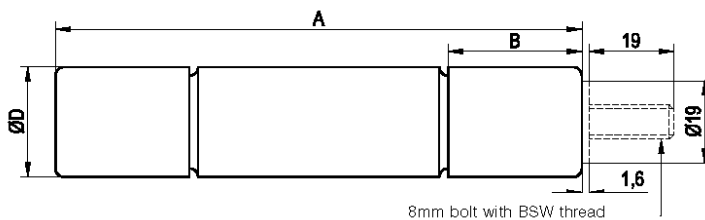

Ferrule fuse links tag type 'A' shown in full lines and '22': tag shown in dotted lines

Part Numbers

Part Number	Rated Current I_n (A)	Breaking Capacity I_1 (kA)	Cold Resistance $m\Omega$	Joule Integral (I^2t)		Length mm	Diameter mm	Weight kg
				Minimum Pre-Arcing	Maximum Operating			
17.5ABGN*3.15	3.15	35	1.45	6.3×10^0	4.0×10^1	359	25.4	0.43
17.5OBGN*3.15	3.15	35	1.45	6.3×10^0	4.0×10^1	359	25.4	0.43

* The last letter of the ordering code on these items is normally either "A" or "22", please refer to how to order page 7 and 8.

24kV - Voltage and Auxiliary Transformer Fuse Links

Specifications

Description: Voltage transformer fuse links

Ratings:

Rated Voltage: 24kV
 Rated Current: 3.15A
 Breaking Capacity: 25kA

Agency Information: Comply with BS 2692 and IEC 60282-1

Time-Current Curves and Cut-Off Curves: see list page 120 and data on CD at the back of the catalogue.

Dimensions (mm):

Fuse link reference	A mm	B mm	D mm
ABGN*	359	30	25.4
OBGN*	359	30	25.4



Features and Benefits

- *Cool running, low watts loss and power dissipation* thanks to the M-effect ensuring high levels of substation utilisation
- *Silver elements* ensuring high conductivity and low power (revenue) loss
- *100% X-ray*, all our Medium Voltage fuse links are X-rayed ensuring the highest possible standards are maintained

Typical Applications

- Protection of auxiliary transformers

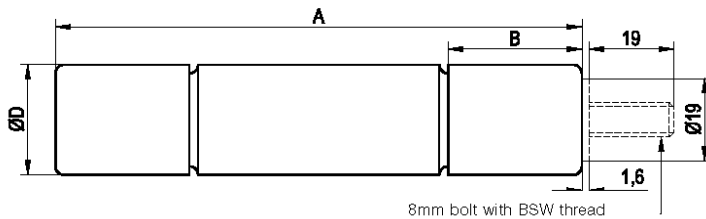

Ferrule fuse links tag type 'A' shown in full lines and '22': tag shown in dotted lines

Part Numbers

Part Number	Rated Current I_n (A)	Breaking Capacity I_1 (kA)	Cold Resistance $m\Omega$	Joule Integral (I^2t)		Length mm	Diameter mm	Weight kg
				Minimum Pre-Arcing	Maximum Operating			
24ABGN*3.15	3.15	25	2	6.3×10^0	4.0×10^1	359	25.4	0.43
24OBGN*3.15	3.15	25	2	6.3×10^0	4.0×10^1	359	25.4	0.43

* The last letter of the ordering code on these items is normally either "A" or "22", please refer to how to order page 7 and 8.

36kV - Voltage and Auxiliary Transformer Fuse Links

Specifications

Description: Voltage transformer fuse links

Ratings:

Rated Voltage: 36kV
 Rated Current: 3.15A
 Breaking Capacity: 31.5kA

Agency Information: Comply with BS 2692 and IEC 60282-1

Time-Current Curves and Cut-Off Curves: see list page 120 and data on CD at the back of the catalogue.

Dimensions (mm):

Fuse link reference	A mm	B mm	D mm
OBN*	359	30	25.4

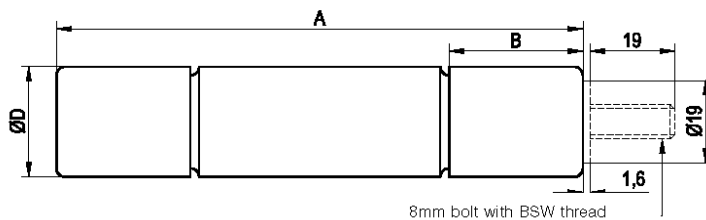

Features and Benefits

- *Cool running, low watts loss and power dissipation* thanks to the M-effect ensuring high levels of substation utilisation
- *Silver elements* ensuring high conductivity and low power (revenue) loss
- *100% X-ray*, all our Medium Voltage fuse links are X-rayed ensuring the highest possible standards are maintained

Typical Applications

- Protection of auxiliary transformers

Ferrule fuse links tag type 'A' shown in full lines and '22': tag shown in dotted lines

Part Numbers

Part Number	Rated Current I_n (A)	Breaking Capacity I_1 (kA)	Cold Resistance m Ω	Joule Integral (I^2t)		Length mm	Diameter mm	Weight kg
				Minimum Pre-Arcing	Maximum Operating			
36OBN*3.15	3.15	31.5	2.05	1.2×10^1	7.7×10^1	359	25.4	0.43

* The last letter of the ordering code on these items is normally either "A" or "22", please refer to how to order page 7 and 8.

3.6kV - Voltage and Auxiliary Transformer Type CAV Fuse Links

Specifications

Description: Voltage transformer fuse links

Ratings:

Rated Voltage: 3.6kV
 Rated Current: 2A
 Breaking Capacity: 50kA

Agency Information: Comply with IEC 60282-1

Time-Current Curves and Cut-Off Curves: see list page 120 and data on CD at the back of the catalogue.

Dimensions (mm):

Fuse link reference	Length A mm
3.6CAV	220

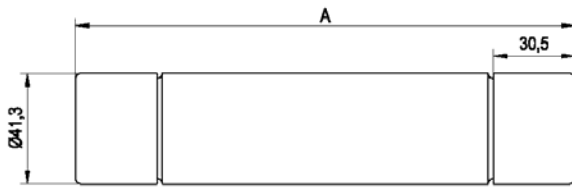

Features and Benefits

- *Cool running, low watts loss and power dissipation* thanks to the M-effect ensuring high levels of substation utilisation
- *Silver elements* ensuring high conductivity and low power (revenue) loss
- *100% X-ray*, all our Medium Voltage fuse links are X-rayed ensuring the highest possible standards are maintained

Typical Applications

- Protection of auxiliary transformers

Part Numbers

Part Number	Rated Current I_n (A)	Breaking Capacity I_1 (kA)	Cold Resistance $m\Omega$	Joule Integral (I^2t)		Length mm	Diameter mm	Weight kg
				Minimum Pre-Arcing	Maximum Operating			
3.6CAV2	2	50	0.492	6.2×10^0	1.8×10^1	220	41.3	0.7

5.5kV - Voltage and Auxiliary Transformer Type CAV Fuse Links

Specifications

Description: Voltage transformer fuse links



Ratings:

Rated Voltage: 5.5kV
 Rated Current: 0.5 - 15A
 Breaking Capacity: 50kA

Agency Information: Comply with IEC 60282-1

Time-Current Curves and Cut-Off Curves: see list page 120 and data on CD at the back of the catalogue.

Dimensions (mm):

Fuse link reference	Length A mm
CAV and CAVH	187

Features and Benefits

- *Cool running, low watts loss and power dissipation* thanks to the M-effect ensuring high levels of substation utilisation
- *Silver elements* ensuring high conductivity and low power (revenue) loss
- *100% X-ray*, all our Medium Voltage fuse links are X-rayed ensuring the highest possible standards are maintained

Typical Applications

- Protection of auxiliary transformers

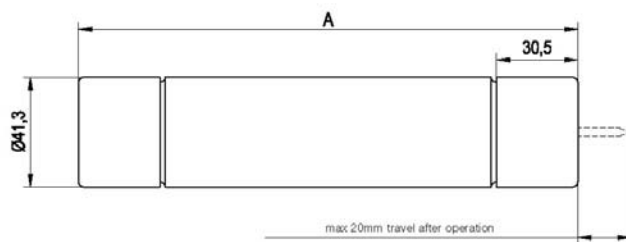

Shown with striker fitted.

Part Numbers

Part Number	Rated Current I_n (A)	Breaking Capacity I_1 (kA)	Cold Resistance $m\Omega$	Joule Integral (I^2t)		Length mm	Diameter mm	Weight kg
				Minimum Pre-Arcing	Maximum Operating			
5.5CAVH0.5E	0.5	50	12.1	1.4×10^1	9.0×10^1	187	41.3	0.6
5.5CAVH1E	1	50	12.1	1.4×10^1	9.0×10^1	187	41.3	0.6
5.5CAVH2E	2	50	0.388	1.8×10^1	1.1×10^2	187	41.3	0.6
5.5CAV15E	15	50	0.488	5.5×10^2	3.5×10^3	187	41.3	0.6

CAV fuse links are suitable for indoor use in air only. Type CAVH fuse links are fitted with striker pins which may be used for indication purposes.

7.2kV - Voltage and Auxiliary Transformer Type CAV Fuse Links

Specifications

Description: Voltage transformer fuse links

Ratings:

Rated Voltage: 7.2kV
 Rated Current: 2 - 10A
 Breaking Capacity: 40kA

Agency Information: Comply with IEC 60282-1

Time-Current Curves and Cut-Off Curves: see list page 120 and data on CD at the back of the catalogue.

Dimensions (mm):

Fuse link reference	Length A mm
CAV	220

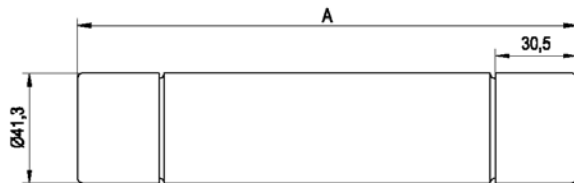

Features and Benefits

- *Cool running, low watts loss and power dissipation* thanks to the M-effect ensuring high levels of substation utilisation
- *Silver elements* ensuring high conductivity and low power (revenue) loss
- *100% X-ray*, all our Medium Voltage fuse links are X-rayed ensuring the highest possible standards are maintained

Typical Applications

- Protection of auxiliary transformers

Part Numbers

Part Number	Rated Current I_n (A)	Breaking Capacity I_1 (kA)	Cold Resistance $m\Omega$	Joule Integral (I^2t)		Length mm	Diameter mm	Weight kg
				Minimum Pre-Arcing	Maximum Operating			
7.2CAV2	2	40	0.893	6.2×10^0	1.8×10^1	220	41.3	0.7
7.2CAV4	4	40	0.503	2.0×10^1	5.7×10^1	220	41.3	0.7
7.2CAV6	6	40	0.321	4.8×10^1	1.4×10^2	220	41.3	0.7
7.2CAV10	10	40	0.215	1.1×10^2	3.2×10^2	220	41.3	0.7

12kV - Voltage and Auxiliary Transformer Type CAV Fuse Links

Specifications

Description: Voltage transformer fuse links

Ratings:

Rated Voltage: 12kV
 Rated Current: 2A
 Breaking Capacity: 40kA

Agency Information: Comply with IEC 60282-1

Time-Current Curves and Cut-Off Curves: see list page 120 and data on CD at the back of the catalogue.

Dimensions (mm):

Fuse link reference	Length A mm
CAV	220



Features and Benefits

- *Cool running, low watts loss and power dissipation* thanks to the M-effect ensuring high levels of substation utilisation
- *Silver elements* ensuring high conductivity and low power (revenue) loss
- *100% X-ray*, all our Medium Voltage fuse links are X-rayed ensuring the highest possible standards are maintained

Typical Applications

- Protection of auxiliary transformers

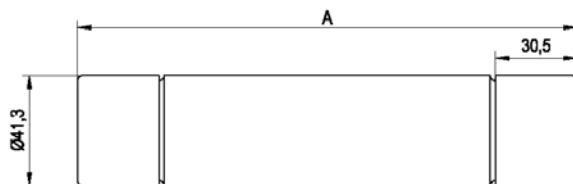

Part Numbers

Part Number	Rated Current I_n (A)	Breaking Capacity I_1 (kA)	Cold Resistance m Ω	Joule Integral (I^2t)		Length mm	Diameter mm	Weight kg
				Minimum Pre-Arcing	Maximum Operating			
12CAV2	2	40	1.34	6.2×10^0	1.8×10^1	220	41.3	0.7

15.5kV - Voltage and Auxiliary Transformer Type CAV Fuse Links

Specifications

Description: Voltage transformer fuse links

Ratings:

Rated Voltage: 15.5kV
 Rated Current: 0.5 - 7A
 Breaking Capacity: 80kA

Agency Information: Comply with IEC 60282-1

Time-Current Curves and Cut-Off Curves: see list page 120 and data on CD at the back of the catalogue.

Dimensions (mm):

Fuse link reference	Length A mm
CAV and CAVH	327

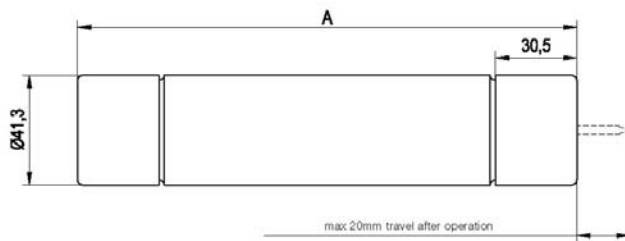

Features and Benefits

- *Cool running, low watts loss and power dissipation* thanks to the M-effect ensuring high levels of substation utilisation
- *Silver elements* ensuring high conductivity and low power (revenue) loss
- *100% X-ray*, all our Medium Voltage fuse links are X-rayed ensuring the highest possible standards are maintained

Typical Applications

- Protection of auxiliary transformers

Part Numbers

Part Number	Rated Current I_n (A)	Breaking Capacity I_1 (kA)	Cold Resistance $m\Omega$	Joule Integral (I^2t)		Length mm	Diameter mm	Weight kg
				Minimum Pre-Arcing	Maximum Operating			
15.5CAV0.5E	0.5	80	151	0.5×10^0	1.5×10^0	327	41.3	0.9
15.5CAV1E	1	80	75.4	2.0×10^0	5.8×10^0	327	41.3	0.9
15.5CAV2E	2	80	32.3	1.2×10^0	3.5×10^0	327	41.3	0.9
15.5CAV3E	3	80	16.2	4.8×10^0	1.4×10^1	327	41.3	0.9
15.5CAV5E	5	80	0.659	2.0×10^1	1.3×10^2	327	41.3	0.9
15.5CAV7E	7	80	0.375	7.1×10^1	4.5×10^2	327	41.3	0.9
15.5CAVH0.5E	0.5	80	30.1	1.4×10^1	9×10^1	327	41.3	0.9
15.5CAVH1E	1	80	30.1	1.4×10^1	9×10^1	327	41.3	0.9
15.5CAVH2E	2	80	0.947	1.8×10^1	1.1×10^2	327	41.3	0.9

CAV fuse links are suitable for indoor use in air only. Type CAVH fuse links are fitted with striker pins which may be used for indication purposes.

17.5kV - Voltage and Auxiliary Transformer Type CAV Fuse Links

Specifications

Description: Voltage transformer fuse links

Ratings:

Rated Voltage: 17.5kV
 Rated Current: 2 - 10A
 Breaking Capacity: 40kA

Agency Information: Comply with IEC 60282-1

Time-Current Curves and Cut-Off Curves: see list page 120 and data on CD at the back of the catalogue.

Dimensions (mm):

Fuse link reference	Length A mm
CAV	220

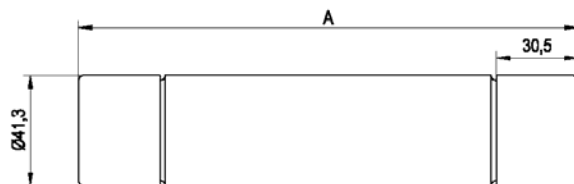

Features and Benefits

- *Cool running, low watts loss and power dissipation* thanks to the M-effect ensuring high levels of substation utilisation
- *Silver elements* ensuring high conductivity and low power (revenue) loss
- *100% X-ray*, all our Medium Voltage fuse links are X-rayed ensuring the highest possible standards are maintained

Typical Applications

- Protection of auxiliary transformers

Part Numbers

Part Number	Rated Current I_n (A)	Breaking Capacity I_1 (kA)	Cold Resistance $m\Omega$	Joule Integral (I^2t)		Length mm	Diameter mm	Weight kg
				Minimum Pre-Arcing	Maximum Operating			
17.5CAV2	2	40	1.69	6.3×10^0	1.8×10^1	220	41.3	0.7
17.5CAV4	4	40	0.611	4.8×10^1	1.4×10^2	220	41.3	0.7
17.5CAV6	6	40	0.362	1.4×10^2	4.0×10^2	220	41.3	0.7
17.5CAV10	10	40	0.239	3.2×10^2	9.2×10^2	220	41.3	0.7

24kV - Voltage and Auxiliary Transformer Type CAV Fuse Links

Specifications

Description: Voltage transformer fuse links

Ratings:

Rated Voltage: 24kV
 Rated Current: 2 - 4A
 Breaking Capacity: 40kA

Agency Information: Comply with IEC 60282-1

Time-Current Curves and Cut-Off Curves: see list page 120 and data on CD at the back of the catalogue.

Dimensions (mm):

Fuse link reference	Length A mm
CAV	340



Features and Benefits

- *Cool running, low watts loss and power dissipation* thanks to the M-effect ensuring high levels of substation utilisation
- *Silver elements* ensuring high conductivity and low power (revenue) loss
- *100% X-ray*, all our Medium Voltage fuse links are X-rayed ensuring the highest possible standards are maintained

Typical Applications

- Protection of auxiliary transformers

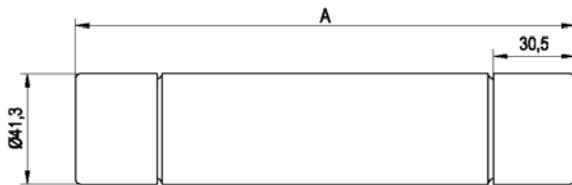

Part Numbers

Part Number	Rated Current I_n (A)	Breaking Capacity I_1 (kA)	Cold Resistance $m\Omega$	Joule Integral (I^2t)		Length mm	Diameter mm	Weight kg
				Minimum Pre-Arcing	Maximum Operating			
24CAV2	2	40	2.54	6.2×10^0	1.8×10^1	340	41.3	1.0
24CAV3	3	40	1.43	2.0×10^1	5.7×10^1	340	41.3	1.0
24CAV4	4	40	0.916	4.8×10^1	1.4×10^2	340	41.3	1.0

36kV - Voltage Transformer and Auxiliary Type CAV Fuse Links

Specifications

Description: Voltage transformer fuse links

Ratings:

Rated Voltage: 36kV
 Rated Current: 2 - 4A
 Breaking Capacity: 40kA

Agency Information: Comply with IEC 60282-1

Time-Current Curves and Cut-Off Curves: see list page 120 and data on CD at the back of the catalogue.

Dimensions (mm):

Fuse link reference	Length A mm
CAV	440

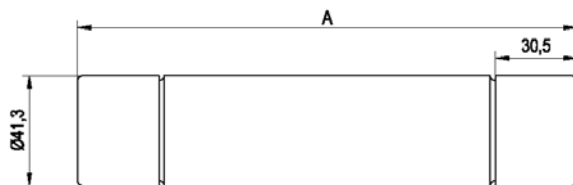

Features and Benefits

- *Cool running, low watts loss and power dissipation* thanks to the M-effect ensuring high levels of substation utilisation
- *Silver elements* ensuring high conductivity and low power (revenue) loss
- *100% X-ray*, all our Medium Voltage fuse links are X-rayed ensuring the highest possible standards are maintained

Typical Applications

- Protection of auxiliary transformers

Part Numbers

Part Number	Rated Current I_n (A)	Breaking Capacity I_1 (kA)	Cold Resistance m Ω	Joule Integral (I^2t)		Length mm	Diameter mm	Weight kg
				Minimum Pre-Arcing	Maximum Operating			
36CAV2	2	40	3.12	6.2×10^0	1.8×10^1	440	41.3	1.2
36CAV4	4	40	1.12	4.8×10^1	1.4×10^2	440	41.3	1.2

38kV - Voltage and Auxiliary Transformer Type CAV Fuse Links

Specifications

Description: Voltage transformer fuse links

Ratings:

Rated Voltage: 38kV
 Rated Current: 0.5 - 4A
 Breaking Capacity: 40kA

Agency Information: Comply with IEC 60282-1

Time-Current Curves and Cut-Off Curves: see list page 120 and data on CD at the back of the catalogue.

Dimensions (mm):

Fuse link reference	Length A mm
CAV and CAVH	440

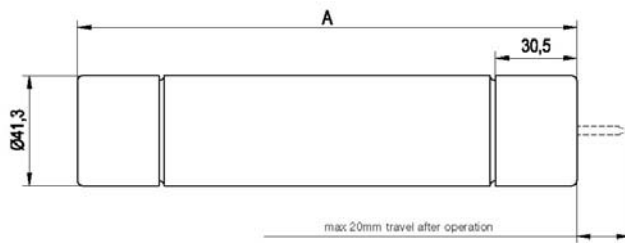

Shown with striker fitted.



Features and Benefits

- *Cool running, low watts loss and power dissipation* thanks to the M-effect ensuring high levels of substation utilisation
- *Silver elements* ensuring high conductivity and low power (revenue) loss
- *100% X-ray*, all our Medium Voltage fuse links are X-rayed ensuring the highest possible standards are maintained

Typical Applications

- Protection of auxiliary transformers

Part Numbers

Part Number	Rated Current I_n (A)	Breaking Capacity I_1 (kA)	Cold Resistance $m\Omega$	Joule Integral (I^2t)		Length mm	Diameter mm	Weight kg
				Minimum Pre-Arcing	Maximum Operating			
38CAV4E	4	40	2.42	1.2×10^1	3.4×10^1	440	41.3	1.2
38CAVH0.5E	0.5	40	66.6	1.4×10^1	9.0×10^1	440	41.3	1.2
38CAVH1E	1	40	66.6	1.4×10^1	9.0×10^1	440	41.3	1.2
38CAVH2E	2	40	2.2	1.8×10^1	1.1×10^2	440	41.3	1.2

CAV fuse links are suitable for indoor use in air only. Type CAVH fuse links are fitted with striker pins which may be used for indication purposes.

Medium Voltage Oil Fuse Links



Introduction to Current Limiting Fuse Links for Use in Oil Switchgear... 56

British Standard

3.6kV.....	57
7.2kV.....	58
12kV	59
15.5kV.....	60
17.5kV.....	61
24kV.....	62

Introduction to Current Limiting Fuse Links for Use in Oil Switchgear

- Fuse Links comply with IEC 60282-1, BS 2692-1 and ESI standard 12-8.
- 7.2 and 12kV Fuse links tested at highest system voltage and approved by the UK Electricity Association approvals panel.
- Voltage ranges from 3.6 to 24kV.
- Fitted with powerful pyrotechnic striker pin.



Cooper Bussmann Under Oil Fuse Links

Cooper Bussmann range of oil tight fuse links are designed for use in oil filled switchgear. This type was pioneered in the UK. Cooper Bussmann range has been in continuous manufacture for almost 40 years, being by far the most widely used device of its kind in the world. Over 1,000,000 Cooper Bussmann branded fuse links have been put into service without a single reported case of oil ingress. A unique triple seal system ensures against long term seal deterioration. Low power dissipation ensures long running in oil filled switchgear.

Application

Oil medium voltage fuse links are suitable for primary side transformer protection and oil filled switch combination unit. *The range is not suitable for use inside oil filled transformer tanks where high oil temperatures may be expected.*

Application Procedure

For any transformer the fuse current rating is determined by magnitude and duration of inrush current.

General Guide to the Selection of Oil Tight Fuse Links for Use in Primary Circuit of Three Phase Transformers

Transformer kVA	Transformer Priority Voltage												
	3.3kV			6.6kV			11kV			13.8kV			
	Product Code	Rated Current (A)	Rated Voltage kV	Product Code	Rated Current (A)	Rated Voltage kV	ESI 12-8 Ref	Product Code	Rated Current (A)	Rated Voltage kV	Product Code	Rated Current (A)	Rated Voltage kV
200	OEFMA	63	3.6	OEFMA	31.5	12	01	OEFMA	25	12	OEFMA	16	15.5
250	OEFMA	80	3.6	OEFMA	40	12	-	OEFMA	25	12	OEFMA	20	15.5
300/315	OEFMA	100	3.6	OEFMA	50	12	02	OEFMA	31.5	12	OEFMA	25	15.5
400	OEFMA	125	3.6	OEFMA	63	12	-	OEFMA	40	12	OEFMA	31.5	15.5
500	OEFMA	160	3.6	OEFMA	71	12	03	OEFMA	50	12	OEFMA	40	15.5
630	OEFMA	200	3.6	OEFMA	100	7.2	-	OEFMA	63	12	OEFMA	50	15.5
750/800	OLGMA	250	3.6	OHGMA	125	7.2	04	OEFMA	80	12	OEFMA	63	15.5
1000	OLGMA	250*	3.6	OHGMA	140	7.2	05	OGFMA	90**	12	OHGMA	71	15.5
1250	-	-	-	OHGMA	160*	7.2	-	OGFMA	100	12	OHGMA	90	15.5
1600	-	-	-	-	-	-	-	OLGMA	125*	12	OLGMA	100*	15.5

Selection of these fuse links has been based on a compromise between the following:

- 1 - Withstand against magnetising inrush current is taken as 12 times full-load current for 0.1 second.
- 2 - Withstand against 150% permissible overload current. Recommendations marked with the following:
 - * Limited to permissible overload of 130%
 - ** Permits use of a 12kV OHFMA 80A fuse link with a 1000kVA transformer where permissible overload does not exceed 130%.
- 3 - For 6.6kV systems, 12kV fuse links are recommended where possible in the interests of standardisation.
- 4 - Wherever possible, 254mm long fuse links are offered rather than equivalent 359mm types
- 5 - The above recommendations are not generally applicable to transformers feeding motor circuits with starting currents in excess of the transformer full load current. In this event please consult Cooper Bussmann application engineers: buletechnical@cooperindustries.com.

3.6kV - British Standard Oil Tight Fuse Links

Specifications

Description: Oil tight fuse links

Ratings:

Rated Voltage: 3.6kV
 Rated Current: 6.3 - 250A
 Breaking Capacity: 50kA

Agency Information: Comply with IEC 60282-1, BS 2692-1 and ESI standard 12-8

Time-Current Curves and Cut-Off Curves: see list page 121 and data on CD at the back of the catalogue.

Dimensions (mm):

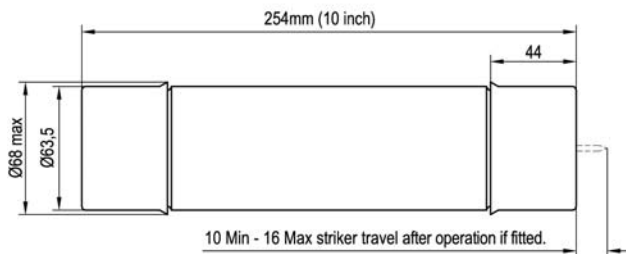

Features and Benefits

- *Cool running, low watts loss and power dissipation* thanks to the M-effect ensuring high levels of substation utilisation
- *Silver elements* ensuring high conductivity and low power (revenue) loss
- *100% X-ray*, all our Medium Voltage fuse links are X-rayed ensuring the highest possible standards are maintained

Typical Applications

- Primary side transformer protection
- Oil filled fuse switch combination unit

The range is not suitable for use inside oil filled transformer tanks where high oil temperatures may be expected

Part Numbers

Part Number	Rated Current I_n (A)	Breaking Capacity I_1 (kA)	Cold Resistance m Ω	Joule Integral (I^2t)		Dimensional Reference BS 2692	Length mm	Diameter mm	Weight kg
				Minimum Pre-Arcing	Maximum Operating				
3.6OEFMA6.3	6.3	50	207	2.0×10^1	4.9×10^2	F01	254	63.5	1.9
3.6OEFMA10	10	50	83.6	1.4×10^2	1.4×10^3	F01	254	63.5	1.9
3.6OEFMA16	16	50	42.5	1.7×10^2	2.4×10^3	F01	254	63.5	1.9
3.6OEFMA20	20	50	33.9	2.7×10^2	3.6×10^3	F01	254	63.5	1.9
3.6OEFMA25	25	50	26.5	4.5×10^2	4.8×10^3	F01	254	63.5	1.9
3.6OEFMA31.5	31.5	50	17.6	1.0×10^3	8.8×10^3	F01	254	63.5	1.9
3.6OEFMA40	40	50	15.4	8.9×10^3	1.0×10^4	F01	254	63.5	1.9
3.6OEFMA50	50	50	11.5	1.6×10^3	1.4×10^4	F01	254	63.5	1.9
3.6OEFMA63	63	50	7.60	3.3×10^3	2.4×10^4	F01	254	63.5	1.9
3.6OEFMA80	80	50	6.03	5.2×10^3	3.4×10^4	F01	254	63.5	1.9
3.6OEFMA100	100	50	4.02	1.2×10^4	6.2×10^4	F01	254	63.5	1.9
3.6OEFMA125	125	50	3.02	2.1×10^4	9.6×10^4	F01	254	63.5	1.9
3.6OEFMA160	160	50	2.21	1.5×10^4	1.6×10^5	F01	254	63.5	1.9
3.6OEFMA200	200	50	1.74	2.4×10^4	2.3×10^5	F01	254	63.5	1.9
3.6OEGMA63	6.3	50	11	3.2×10^3	1.9×10^4	F02	254	63.5	2.6
3.6OEGMA80	80	50	8.70	5.2×10^3	2.7×10^4	F02	254	63.5	2.6
3.6OEGMA100	100	50	5.5	5.0×10^3	4.9×10^4	F02	254	63.5	2.6
3.6OEGMA125	125	50	4.59	7.2×10^3	6.4×10^4	F02	254	63.5	2.6
3.6OEGMA160	160	50	3.44	1.3×10^4	1.0×10^5	F02	254	63.5	2.6
3.6OEGMA200	200	50	2.29	2.9×10^4	1.8×10^5	F02	254	63.5	2.6
3.6OLGMA250	250	50	1.72	5.1×10^4	2.7×10^5	F02	254	63.5	2.6

7.2kV - British Standard Oil Tight Fuse Links

Specifications

Description: Oil tight fuse links

Ratings:

Rated Voltage: 7.2kV
 Rated Current: 80 - 160A
 Breaking Capacity: 45kA

Agency Information: Comply with IEC 60282-1, BS 2692-1 and ESI standard 12-8

Time-Current Curves and Cut-Off Curves: see list page 121 and data on CD at the back of the catalogue.

Dimensions (mm):

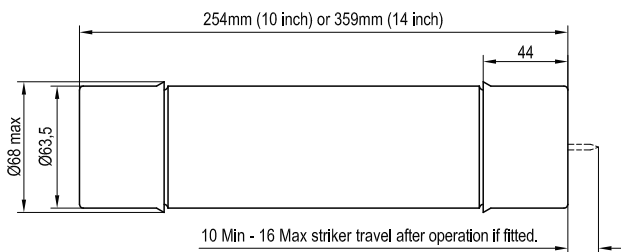

Features and Benefits

- *Cool running, low watts loss and power dissipation* thanks to the M-effect ensuring high levels of substation utilisation
- *Silver elements* ensuring high conductivity and low power (revenue) loss
- *100% X-ray*, all our Medium Voltage fuse links are X-rayed ensuring the highest possible standards are maintained

Typical Applications

- Primary side transformer protection
- Oil filled fuse switch combination unit

The range is not suitable for use inside oil filled transformer tanks where high oil temperatures may be expected

Part Numbers

Part Number	Rated Current I_n (A)	Breaking Capacity I_1 (kA)	Cold Resistance $m\Omega$	Joule Integral (I^2t)		Dimensional Reference BS 2692	Length mm	Diameter mm	Weight kg
				Minimum Pre-Arcing	Maximum Operating				
7.2OEFMA80	80	45	8.36	3.2×10^3	5.8×10^4	F01	254	63.5	1.9
7.2OEFMA100	100	45	5.59	6.3×10^3	9.0×10^4	F01	254	63.5	1.9
7.2OEFMA112	112	45	4.57	9.1×10^3	1.3×10^5	F01	254	63.5	1.9
7.2OHGMA100	100	45	6.09	5.0×10^3	7.5×10^4	F02	359	63.5	2.6
7.2OHGMA125	125	45	5.08	7.2×10^2	9.6×10^4	F02	359	63.5	2.6
7.2OHGMA140	140	45	4.35	9.8×10^3	1.4×10^5	F02	359	63.5	2.6
7.2OHGMA160	160	45	3.81	1.3×10^4	1.8×10^5	F02	359	63.5	2.6

12kV - British Standard Oil Tight Fuse Links

Specifications

Description: Oil tight fuse links

Ratings:

Rated Voltage: 12kV
 Rated Current: 6.3 - 125A
 Breaking Capacity: 40 - 45kA

Agency Information: Comply with IEC 60282-1, BS 2692-1 and ESI standard 12-8

Time-Current Curves and Cut-Off Curves: see list page 121 and data on CD at the back of the catalogue.

Dimensions (mm):

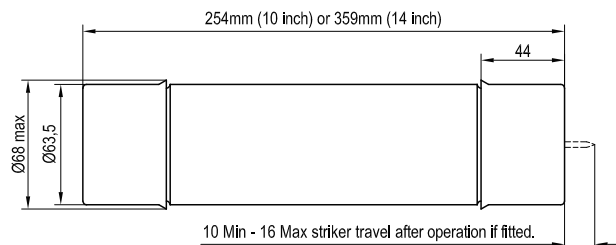

Features and Benefits

- *Cool running, low watts loss and power dissipation* thanks to the M-effect ensuring high levels of substation utilisation
- *Silver elements* ensuring high conductivity and low power (revenue) loss
- *100% X-ray*, all our Medium Voltage fuse links are X-rayed ensuring the highest possible standards are maintained

Typical Applications

- Primary side transformer protection
- Oil filled fuse switch combination unit

The range is not suitable for use inside oil filled transformer tanks where high oil temperatures may be expected

Part Numbers

Part Number	Rated Current I_n (A)	Breaking Capacity I_1 (kA)	Cold Resistance m Ω	Joule Integral (I^2t)		Dimensional Reference BS 2692	Length mm	Diameter mm	Weight kg
				Minimum Pre-Arcing	Maximum Operating				
12OEFMA6.3	6.3	40	520	2.0×10^1	6.1×10^2	F01	254	63.5	1.9
12OEFMA10	10	40	214	1.4×10^2	1.8×10^3	F01	254	63.5	1.9
12OEFMA16	16	40	108	1.7×10^2	3.0×10^3	F01	254	63.5	1.9
12OEFMA20	20	40	77	3.4×10^2	5.0×10^3	F01	254	63.5	1.9
12OEFMA25	25	40	57.8	4.0×10^2	6.5×10^3	F01	254	63.5	1.9
12OEFMA31.5	31.5	40	38.5	8.9×10^2	1.2×10^4	F01	254	63.5	1.9
12OEFMA40	40	40	28.2	1.5×10^3	1.8×10^4	F01	254	63.5	1.9
12OEFMA50	50	40	20.1	2.9×10^3	2.8×10^4	F01	254	63.5	1.9
12OEFMA63	63	40	15.1	5.1×10^3	4.3×10^4	F01	254	63.5	1.9
12OHFMA71	71	45	12.3	3.2×10^3	5.4×10^4	F01	254	63.5	1.9
12OHFMA80	80	45	10.9	4.1×10^3	7.0×10^4	F01	254	63.5	1.9
12OHGMA6.3	6.3	40	520	2.0×10^1	6.1×10^2	F02	359	63.5	2.6
12OHGMA10	10	40	214	1.4×10^2	1.8×10^3	F02	359	63.5	2.6
12OHGMA16	16	40	108	1.7×10^2	3.0×10^3	F02	359	63.5	2.6
12OHGMA20	20	40	77	3.4×10^2	5.0×10^3	F02	359	63.5	2.6
12OHGMA25	25	40	57.8	4.0×10^2	6.5×10^3	F02	359	63.5	2.6
12OHGMA31.5	31.5	40	38.5	8.9×10^2	1.2×10^4	F02	359	63.5	2.6
12OHGMA40	40	40	28.2	1.5×10^3	1.8×10^4	F02	359	63.5	2.6
12OHGMA50	50	40	22.6	2.3×10^3	2.4×10^4	F02	359	63.5	2.6
12OHGMA63	63	40	17	4.1×10^3	3.7×10^4	F02	359	63.5	2.6
12OHGMA71	71	40	16.6	2.0×10^3	3.9×10^4	F02	359	63.5	2.6
12OHGMA80	80	40	13.4	3.2×10^3	5.5×10^4	F02	359	63.5	2.6
12OHGMA90	90	40	12.2	3.8×10^3	6.2×10^4	F02	359	63.5	2.6
12OHGMA100	100	40	8.75	6.3×10^3	8.9×10^4	F02	359	63.5	2.6
12OLGMA125	125	40	7.09	1.0×10^4	1.7×10^5	F02	359	63.5	2.6

15.5kV - British Standard Oil Tight Fuse Links

Specifications

Description: Oil tight fuse links

Ratings:

Rated Voltage: 15.5kV
 Rated Current: 6.3 - 100A
 Breaking Capacity: 40kA

Agency Information: Comply with IEC 60282-1, BS 2692-1 and ESI standard 12-8

Time-Current Curves and Cut-Off Curves: see list page 121 and data on CD at the back of the catalogue.

Dimensions (mm):

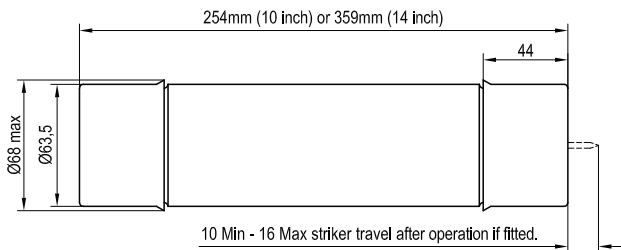

Features and Benefits

- *Cool running, low watts loss and power dissipation* thanks to the M-effect ensuring high levels of substation utilisation
- *Silver elements* ensuring high conductivity and low power (revenue) loss
- *100% X-ray*, all our Medium Voltage fuse links are X-rayed ensuring the highest possible standards are maintained

Typical Applications

- Primary side transformer protection
- Oil filled fuse switch combination unit

The range is not suitable for use inside oil filled transformer tanks where high oil temperatures may be expected

Part Numbers

Part Number	Rated Current I_n (A)	Breaking Capacity I_1 (kA)	Cold Resistance $m\Omega$	Joule Integral (I^2t)		Dimensional Reference BS 2692	Length mm	Diameter mm	Weight kg
				Minimum Pre-Arcing	Maximum Operating				
15.5OEFMA6.3	6.3	40	392	4.8×10^1	1×10^3	F01	254	63.5	1.9
15.5OEFMA10	10	40	188	4×10^1	3.4×10^3	F01	254	63.5	1.9
15.5OEFMA16	16	40	101	2.7×10^1	3.4×10^3	F01	254	63.5	1.9
15.5OEFMA20	20	40	78.7	4.5×10^1	4.9×10^3	F01	254	63.5	1.9
15.5OEFMA25	25	40	55.3	5.2×10^1	1.1×10^4	F01	254	63.5	1.9
15.5OEFMA31.5	31.5	40	36.9	1.2×10^3	1.5×10^4	F01	254	63.5	1.9
15.5OEFMA40	40	40	29.5	1.8×10^3	1.5×10^4	F01	254	63.5	1.9
15.5OEFMA50	50	40	22.1	3.3×10^3	3.0×10^4	F01	254	63.5	1.9
15.5OEFMA63	63	40	17.8	2×10^3	3.9×10^4	F01	254	63.5	1.9
15.5OHGMA71	71	40	17.7	2.5×10^3	4.4×10^4	F02	359	63.5	2.6
15.5OHGMA80	80	40	15.5	3.2×10^3	5.4×10^4	F02	359	63.5	2.6
15.5OHGMA16	90	40	11.6	5×10^3	7.5×10^4	F02	359	63.5	2.6
15.5OLGMA100	100	40	10	7.2×10^3	9.6×10^4	F02	359	63.5	2.6

17.5kV - British Standard Oil Tight Fuse Links

Specifications

Description: Oil tight fuse links

Ratings:

Rated Voltage: 17.5kV
 Rated Current: 6.3 - 80A
 Breaking Capacity: 35kA

Agency Information: Comply with IEC 60282-1, BS 2692-1 and ESI standard 12-8

Time-Current Curves and Cut-Off Curves: see list page 121 and data on CD at the back of the catalogue.

Dimensions (mm):

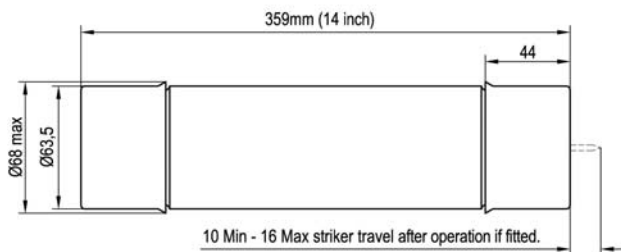

Features and Benefits

- *Cool running, low watts loss and power dissipation* thanks to the M-effect ensuring high levels of substation utilisation
- *Silver elements* ensuring high conductivity and low power (revenue) loss
- *100% X-ray*, all our Medium Voltage fuse links are X-rayed ensuring the highest possible standards are maintained

Typical Applications

- Primary side transformer protection
- Oil filled fuse switch combination unit

The range is not suitable for use inside oil filled transformer tanks where high oil temperatures may be expected

Part Numbers

Part Number	Rated Current I_n (A)	Breaking Capacity I_1 (kA)	Cold Resistance mΩ	Joule Integral (I^2t)		Dimensional Reference BS 2692	Length mm	Diameter mm	Weight kg
				Minimum Pre-Arcing	Maximum Operating				
17.5OHGMA6.3	6.3	35	665	2×10^1	6.1×10^2	F02	359	63.5	2.6
17.5OHGMA10	10	35	282	1.4×10^2	1.8×10^3	F02	359	63.5	2.6
17.5OHGMA16	16	35	139	1.7×10^2	3.0×10^3	F02	359	63.5	2.6
17.5OHGMA20	20	35	100	3.4×10^2	5.0×10^3	F02	359	63.5	2.6
17.5OHGMA25	25	35	74.7	4×10^2	6.5×10^3	F02	359	63.5	2.6
17.5OHGMA31.5	31.5	35	49.8	9×10^2	1.2×10^4	F02	359	63.5	2.6
17.5OHGMA40	40	35	36.5	1.5×10^3	1.9×10^4	F02	359	63.5	2.6
17.5OHGMA50	50	35	26.0	2.9×10^3	2.9×10^4	F02	359	63.5	2.6
17.5OHGMA63	63	35	19.5	5.2×10^3	4.5×10^4	F02	359	63.5	2.6
17.5OHGMA80	80	35	15.5	3.8×10^3	5.7×10^4	F02	359	63.5	2.6

24kV - British Standard Oil Tight Fuse Links

Specifications

Description: Oil tight fuse links

Ratings:

Rated Voltage: 24kV
 Rated Current: 6.3 - 50A
 Breaking Capacity: 25kA

Agency Information: Comply with IEC 60282-1, BS 2692-1 and ESI standard 12-8

Time-Current Curves and Cut-Off Curves: see list page 121 and data on CD at the back of the catalogue.

Dimensions (mm):

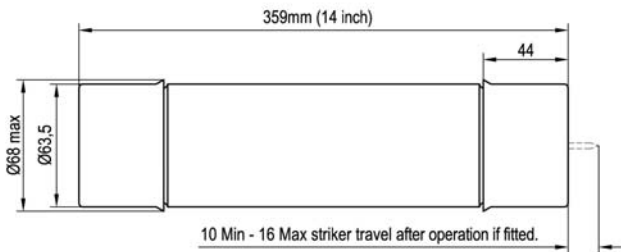

Features and Benefits

- *Cool running, low watts loss and power dissipation* thanks to the M-effect ensuring high levels of substation utilisation
- *Silver elements* ensuring high conductivity and low power (revenue) loss
- *100% X-ray*, all our Medium Voltage fuse links are X-rayed ensuring the highest possible standards are maintained

Typical Applications

- Primary side transformer protection
- Oil filled fuse switch combination unit

The range is not suitable for use inside oil filled transformer tanks where high oil temperatures may be expected

Part Numbers

Part Number	Rated Current I_n (A)	Breaking Capacity I_1 (kA)	Cold Resistance m Ω	Joule Integral (I^2t)		Dimensional Reference BS 2692	Length mm	Diameter mm	Weight kg
				Minimum Pre-Arcing	Maximum Operating				
24OEGMA6.3	6.3	25	605	4.8×10^1	1.0×10^3	F02	359	63.5	2.6
24OEGMA10	10	25	290	2.5×10^2	3.4×10^3	F02	359	63.5	2.6
24OEGMA16	16	25	153	2.7×10^2	3.4×10^3	F02	359	63.5	2.6
24OEGMA20	20	25	119	4.4×10^2	4.9×10^3	F02	359	63.5	2.6
24OEGMA25	25	25	84.5	5.2×10^2	1.1×10^4	F02	359	63.5	2.6
24OEGMA31.5	31.5	25	55.9	1.2×10^3	1.5×10^4	F02	359	63.5	2.6
24OEGMA40	40	25	44.7	1.8×10^3	2.0×10^4	F02	359	63.5	2.6
24OEGMA50	50	25	34	1.2×10^3	2.4×10^4	F02	359	63.5	2.6

Medium Voltage British Standard Air Fuse Links



Introduction to Current Limiting Fuse Links for Use in Air.....	64 - 65
British Standard	
3.6kV.....	66 - 67
7.2kV.....	68 - 69
12kV.....	70 - 71
15.5kV.....	72
24kV.....	73
36kV.....	74
72.5kV.....	75

Introduction to Current Limiting Fuse Links for Use in Air

- Medium Voltage fuse links for use in Air, comply with BS 2962-1 dimensions.
- Available in voltage from 3.6kV to 72.5kV.
- Full range performance option available at 12kV and 24kV.
- Wide variety of fixing arrangements available.
- Powerful pyrotechnic striker fitted.
- E-rated North American dimension products also available.
- Suitable for indoor and outdoor use.



Cooper Bussmann Fuse Links for Use in Air

The Cooper Bussmann range of fuse links for use in air are available in British Standard form, BS 2692, Part 1 1975. A number of options are available, including full range capability, and alternative fixing arrangements such as different types of tags, studs and collars etc. Details are available on application. Higher current ratings can be obtained by using fuse links in parallel and special fixing arrangements are available for this purpose.

Cooper Bussmann - USA Dimensions

A comprehensive range of 'E' rated North American Dimension fuse links for industrial applications is also available. These are the latest technology full range fuse links in USA Industrial Standard 2 inch and 3 inch diameter ferrule style. Extended ratings in double barrel assemblies; striker, indicator and tag versions are also available, see page 76 to 93.

Application

Air fuse links are suitable for primary side transformer protection, fuse switch combination unit, fuse bases and fuse switches.

General Guide to the Selection of Air Fuse Links for use in the Primary Circuit of Three Phase Transformers

Transformer kVA	Transformer Priority Voltage								
	6.6kV			11kV			13.8kV		
	Product Code	Rated Current (A)	Rated Voltage (kV)	Product Code	Rated Current (A)	Rated Voltage (kV)	Product Code	Rated Current (A)	Rated Voltage (kV)
200	BDG	31.5	12	BDG	20	12	BDG	20	15.5
250	BDG	40	12	BDG	25	12	BDG	25	15.5
300/315	BDG	50	12	BDG	31.5	12	BDG	31.5	15.5
400	BFG	63	12	BDG	40	12	BDG	40	15.5
500	BFG	80	12	BDG	50	12	BFG	50	15.5
630	BFG	90	12	BFG	63	12	BFG	63	15.5
750/800	BFG	125	7.2	BFG	71	12	BFG	63	15.5
1000	BFG	140	7.2	BFG	90	12	BFG	85	15.5
1250	BFG	160	7.2	AKG	112	12	BFG	85*	15.5
1500	BFG	160*	7.2	AKG	125*	12	-	-	-

Selection of fuse these links has been based on a compromise between the following:

- 1 - The fuse links should withstand transformer magnetising inrush currents, taken as 12 times full load current for 0.1 seconds.
- 2 - The fuse links should discriminate with the highest rating of secondary fuse links
- 3 - The fuse links should withstand periodic overcurrents of up to 150% of transformer fuse load current
- 4 - The fuse links should operate reasonably quickly in the event of a transformer inter-turn fault or a fault in the secondary terminal zone of the transformer

Notes

a) The above recommendations are not generally applicable to transformers feeding motor circuits with starting currents in excess of the rated current fuse. In this event, please consult Cooper Bussmann application engineers.

b) For 6.6kV transformers, 12kV fuse links are recommended, where the required current rating is available.

* Where the transformer is not subjected to periodic overcurrents, a lower fuse rating may be suitable, fuse ratings marked with “*”, are only suitable for use with the transformer sizes quoted, where significant over loading does not occur.

Fuse links for use in transformers with primary voltages of 3.3, 22 and 33kV are available, please consult Cooper Bussmann application engineers for further details buletechnical@cooperindustries.com.

3.6kV - British Standard Air Fuse Links

Specifications

Description: Air fuse links

Ratings:

Rated Voltage: 3.6kV
 Rated Current: 6.3 - 100A
 Breaking Capacity: 25 - 40kA

Agency Information: comply with BS 2962-1 dimensions

Time-Current Curves and Cut-Off Curves: see list page 121 and data on CD at the back of the catalogue.

Dimensions (mm):

Tags Type	Code	A	B	C	D \varnothing
A	ADGHA	359	N/A	N/A	51
C & D	ADFHC	356	314	254	51
	ADGHC	461	419	359	51
F	ADFHF	356	314	254	51
	ADGHF	461	419	359	51



Features and Benefits

- *Cool running, low watts loss and power dissipation* thanks to the M-effect ensuring high levels of substation utilisation
- *Silver elements* ensuring high conductivity and low power (revenue) loss
- *100% X-ray*, all our Medium Voltage fuse links are X-rayed ensuring the highest possible standards are maintained

Typical Applications

- Primary side transformer protection
- Used in fuse switch combination unit
- Used in fuse bases
- Used in fuse switches

A Tags

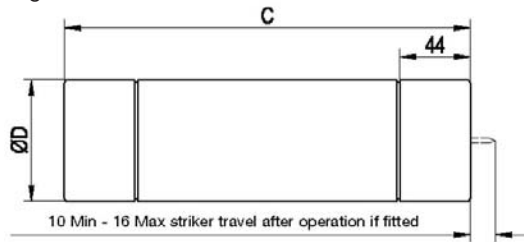

C & D Tags

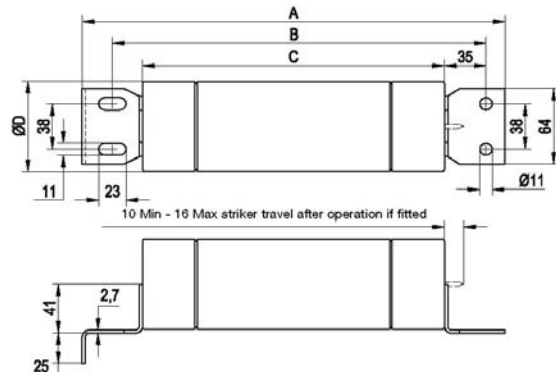

F Tags

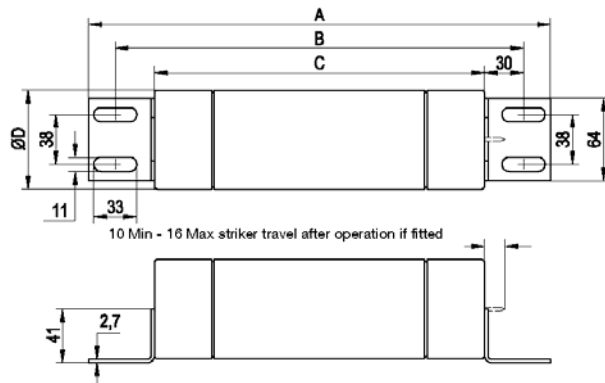

3.6kV - British Standard Air Fuse Links

Part Numbers

Part Number	Rated Current I_n (A)	Breaking Capacity I_1 (kA)	Cold Resistance m Ω	Joule Integral (I^2t)		Length mm	Diameter mm	Weight kg
				Minimum Pre-Arcing	Maximum Operating			
3.6ADFH*6.3	6.3	40	208	4.8×10^1	7.2×10^2	254	50.8	1.5
3.6ADFH*10	10	40	91.8	2.3×10^2	2.3×10^3	254	50.8	1.5
3.6ADFH*16	16	40	31.1	7.2×10^1	1×10^3	254	50.8	1.5
3.6ADFH*20	20	40	24.9	1.1×10^2	1.5×10^3	254	50.8	1.5
3.6ADFH*25	25	40	18.6	2×10^2	2.1×10^3	254	50.8	1.5
3.6ADFH*31.5	31.5	40	14.9	3.1×10^2	2.8×10^3	254	50.8	1.5
3.6ADFH*40	40	40	10	7.1×10^2	7.7×10^3	254	50.8	1.5
3.6ADGH*6.3	6.3	25	185	4.8×10^1	7.2×10^2	359	50.8	2.1
3.6ADGH*10	10	25	77.1	3.1×10^2	4.7×10^3	359	50.8	2.1
3.6ADGH*16	16	25	58.6	5.5×10^2	8.3×10^3	359	50.8	2.1
3.6ADGH*20	20	25	44	9.8×10^2	1.5×10^4	359	50.8	2.1
3.6ADGH*25	25	25	36.9	1.3×10^2	1.5×10^3	359	50.8	2.1
3.6ADGH*31.5	31.5	25	24.6	2.9×10^2	3.5×10^3	359	50.8	2.1
3.6ADGH*40	40	25	13.9	8×10^2	9.6×10^3	359	50.8	2.1
3.6ADGH*50	50	25	9.91	1.6×10^3	1.9×10^4	359	50.8	2.1
3.6ADGH*63	63	25	7.05	3.1×10^3	3.7×10^4	359	50.8	2.1
3.6ADGH*80	80	25	4.94	6.3×10^3	7.6×10^4	359	50.8	2.1
3.6ADGH*100	100	25	3.96	9.8×10^3	1.2×10^5	359	50.8	2.1

* The fifth letter or number of the part reference denotes the end fixing arrangement.

There are a wide variety of end terminations available, the most popular types, some of which have dimensional references to BS2692: Part 1, are:

ADFH* and ADGH*: **C** Special offset tags, two hole fixings for Brush fuse switch equipment, BS Ref TA3

ADFH* and ADGH*: **F** Offset tags two bolt fixing

ADGH*: **A** No tags - Ferrule - BS Ref. FA3 ADIHA / BS Ref FA4 AFIHA / BS Ref FA5 - AFKHA

See previous page for outline drawings and dimensions.

Other tag variants available please consult Cooper Bussmann application engineers buletechnical@cooperindustries.com.

7.2kV - British Standard Air Fuse Links

Specifications

Description: Air fuse links

Ratings:

Rated Voltage: 7.2kV
 Rated Current: 6.3 - 160A
 Breaking Capacity: 20 - 40kA

Agency Information: comply with BS 2962-1 dimensions

Time-Current Curves and Cut-Off Curves: see list page 121 and data on CD at the back of the catalogue.

Dimensions (mm):

Tags Type	Code	A	B	C	D ϕ
A	ADGHA	359	N/A	N/A	51
	BFGHA	359	N/A	N/A	76
C & D	ADFHC	356	314	254	51
	BDGHC	461	419	359	51
F	BFGHD	461	419	359	76
	ADFHF	356	314	254	51
	BDGHF	461	419	359	51
	AFFHF	356	314	254	76
	BFGHF	461	419	359	76



Features and Benefits

- *Cool running, low watts loss and power dissipation* thanks to the M-effect ensuring high levels of substation utilisation
- *Silver elements* ensuring high conductivity and low power (revenue) loss
- *100% X-ray*, all our Medium Voltage fuse links are X-rayed ensuring the highest possible standards are maintained

Typical Applications

- Primary side transformer protection
- Used in fuse switch combination unit
- Used in fuse bases
- Used in fuse switches

A Tags

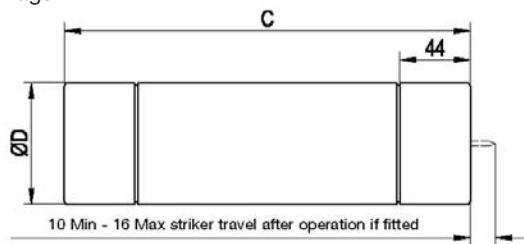

C & D Tags

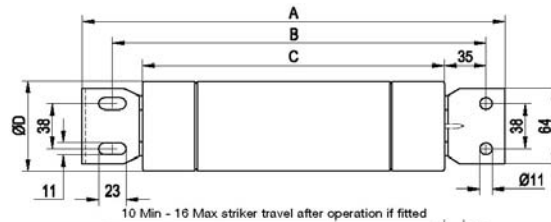

F Tags

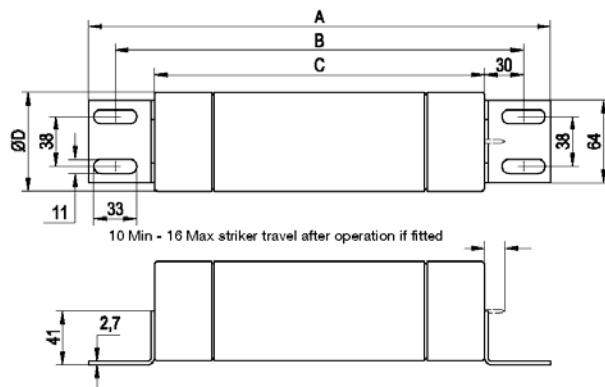

7.2kV - British Standard Air Fuse Links

Part Numbers

Part Number	Rated Current I_n (A)	Breaking Capacity I_1 (kA)	Cold Resistance m Ω	Joule Integral (I^2t)		Length mm	Diameter mm	Weight kg
				Minimum Pre-Arcing	Maximum Operating			
7.2ADFH*6.3	6.3	20	206	4.8×10^1	5.6×10^2	254	50.8	1.5
7.2ADFH*10	10	20	83	7.2×10^1	9.4×10^2	254	50.8	1.5
7.2ADFH*16	16	20	52.3	7.2×10^1	8.6×10^2	254	50.8	1.5
7.2ADFH*20	20	20	41.8	1.1×10^2	1.5×10^3	254	50.8	1.5
7.2ADFH*25	25	20	31.5	2×10^2	2.6×10^3	254	50.8	1.5
7.2ADFH*31.5	31.5	20	22.8	3.8×10^2	4.8×10^3	254	50.8	1.5
7.2ADFH*40	40	20	15.6	8×10^2	1.1×10^4	254	50.8	1.5
7.2ADFH*50	50	20	11.8	1.3×10^3	1.4×10^4	254	50.8	1.5
7.2ADFH*63	63	20	8.41	2.5×10^3	2.9×10^4	254	50.8	1.5
7.2AFFH*80	80	20	5.83	6.3×10^3	6.9×10^4	254	50.8	1.5
7.2AFFH*100	100	20	4.38	9.8×10^3	1.4×10^5	254	50.8	1.5
7.2BDGH*6.3	6.3	40	206	5.1×10^1	6×10^2	359	50.8	2.1
7.2BDGH*10	10	40	83	1×10^2	1.3×10^3	359	50.8	2.1
7.2BDGH*16	16	40	52.3	8.4×10^1	1×10^3	359	50.8	2.1
7.2BDGH*20	20	40	41.8	1.1×10^2	1.5×10^3	359	50.8	2.1
7.2BDGH*25	25	40	31.4	2×10^2	2.6×10^3	359	50.8	2.1
7.2BDGH*31.5	31.5	40	22.8	4.6×10^2	5.8×10^3	359	50.8	2.1
7.2BDGH*40	40	40	15.7	8×10^2	1.1×10^4	359	50.8	2.1
7.2BDGH*50	50	40	11.8	1.6×10^3	1.8×10^4	359	50.8	2.1
7.2BDGH*63	63	40	7.48	3.6×10^3	4.3×10^4	359	50.8	2.1
7.2BDGH*80	80	40	5.82	6.4×10^3	7×10^4	359	50.8	2.1
7.2BFGH*90	90	40	4.72	1×10^4	1.4×10^5	359	76.2	4.2
7.2BFGH*100	100	40	4.05	1.3×10^4	1.9×10^5	359	76.2	4.2
7.2BFGH*125	125	40	3.15	1.6×10^4	1.9×10^5	359	76.2	4.2
7.2BFGH*140	140	40	2.57	2.4×10^4	3.3×10^5	359	76.2	4.2
7.2BFGH*160	160	40	2.35	2.9×10^4	4×10^5	359	76.2	4.2

* The fifth letter or number of the part reference denotes the end fixing arrangement.

There are a wide variety of end terminations available, the most popular types, some of which have dimensional references to BS2692: Part 1, are:

ADFH C : C Special offset tags, two hole fixings for Brush fuse switch equipment , BS Ref TA3

ADFH F : F Offset tags two bolt fixing

AFFH D : D Special offset tags, two hole fixings for Brush fuse switch equipment , BS Ref TA3

AFFH F : F Offset tags two bolt fixing

BDGH C : C Special offset tags, two hole fixings for Brush fuse switch equipment , BS Ref TA3

BDGH A : A No tags - Ferrule - BS Ref. FA3 ADIHA / BS Ref FA4 AFIHA / BS Ref FA5 - AFKHABDGHF

BFGH A : A No tags - Ferrule - BS Ref. FA3 ADIHA / BS Ref FA4 AFIHA / BS Ref FA5 - AFKHA

BFGH F : F Offset tags two bolt fixing

See previous page for outline drawings and dimensions.

Other tag variants available please consult Cooper Bussmann application engineers: buletechnical@cooperindustries.com.

12kV - British Standard Air Fuse Links

Specifications

Description: Air fuse links

Ratings:

Rated Voltage: 12kV
 Rated Current: 6.3 - 125A
 Breaking Capacity: 12 - 40kA

Agency Information: comply with BS 2962-1 dimensions

Time-Current Curves and Cut-Off Curves: see list page 121 and data on CD at the back of the catalogue.

Dimensions (mm):

Tags Type	Code	A	B	C	Dø
A	BDGHA	359	N/A	N/A	51
	AKGHA	359	N/A	N/A	76
	BFGHA	359	N/A	N/A	76
C & D	ADFFHC	356	314	254	51
	BDGHC	461	419	359	51
	AFFHD	356	314	254	76
	AKGHD	461	419	359	76
	BFGHD	461	419	359	76
F	ADFFHF	356	314	254	51
	BDGHF	461	419	359	51
	AFFHF	356	314	254	76
	AKGHF	461	419	359	76
	BFGHF	461 <td 419	359	76	



Features and Benefits

- Cool running, low watts loss and power dissipation thanks to the M-effect ensuring high levels of substation utilisation
- Silver elements ensuring high conductivity and low power (revenue) loss
- 100% X-ray, all our Medium Voltage fuse links are X-rayed ensuring the highest possible standards are maintained

Typical Applications

- Primary side transformer protection
- Used in fuse switch combination unit
- Used in fuse bases
- Used in fuse switches

A Tags

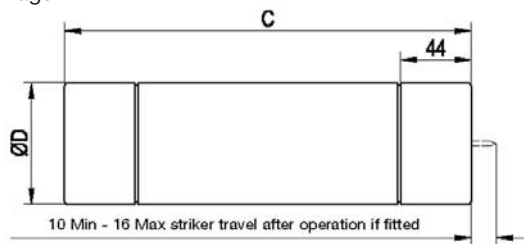

C & D Tags

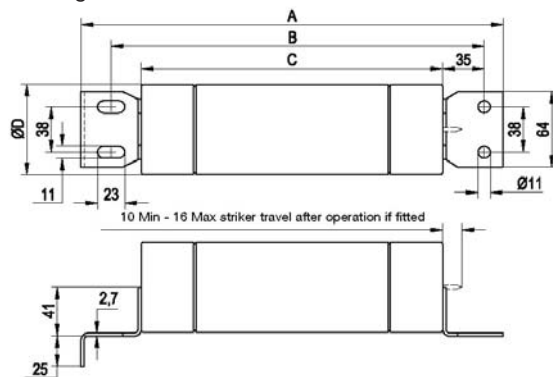

F Tags

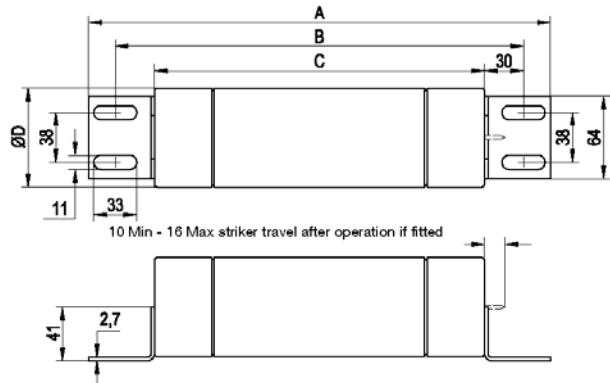

Tag 49

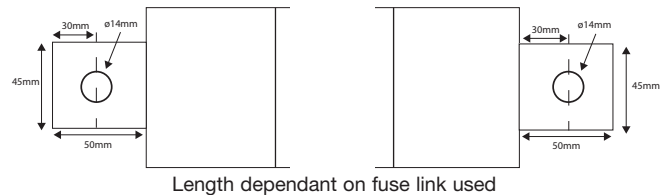

12kV - British Standard Air Fuse Links

Part Numbers

Part Number	Rated Current I_n (A)	Breaking Capacity I_1 (kA)	Cold Resistance m Ω	Joule Integral (I^2t)		Length mm	Diameter mm	Weight kg
				Minimum Pre-Arcing	Maximum Operating			
12ADFH*6.3	6.3	12	356	4.8×10^1	5×10^2	254	50.8	1.5
12ADFH*10	10	12	89.8	1.3×10^2	2×10^3	254	50.8	1.5
12ADFH*16	16	12	56.5	1.3×10^2	2×10^3	254	50.8	1.5
12ADFH*20	20	12	36.2	3.1×10^2	3.5×10^3	254	50.8	1.5
12ADFH*25	25	12	28.3	5.1×10^2	6.1×10^3	254	50.8	1.5
12ADFH*31*5	31.5	12	22.6	8×10^2	9×10^3	254	50.8	1.5
12AFFH*40	40	12	21.8	1.2×10^3	1.5×10^4	254	76.2	2.8
12AFFH*50	50	12	15.7	2×10^3	2.5×10^4	254	76.2	2.8
12AFFH*63	63	12	12.5	3.1×10^3	3.9×10^4	254	76.2	2.8
12BDGH*6.3	6.3	40	356	5.2×10^1	5×10^2	359	50.8	2.1
12BDGH*10	10	40	138	6.4×10^1	1×10^3	359	50.8	2.1
12BDGH*16	16	40	87	6.4×10^1	1×10^3	359	50.8	2.1
12BDGH*20	20	40	63.3	1.6×10^2	1.8×10^3	359	50.8	2.1
12BDGH*25	25	40	43.5	3.2×10^2	3.8×10^3	359	50.8	2.1
12BDGH*31.5	31.5	40	32.6	5.8×10^2	6.5×10^3	359	50.8	2.1
12BDGH*40	40	40	21.8	1.2×10^3	1.5×10^4	359	50.8	2.1
12BDGH*45	45	40	17.5	1.8×10^3	2.3×10^4	359	50.8	2.1
12BDGH*50	50	40	14.5	2.5×10^3	3.2×10^4	359	50.8	2.1
12BFGH*56	56	40	14.6	2.9×10^3	3.7×10^4	359	76.2	4.2
12BFGH*63	63	40	12.8	3.4×10^3	4.5×10^4	359	76.2	4.2
12BFGH*71	71	40	10.6	4.6×10^3	6.3×10^4	359	76.2	4.2
12BFGH*80	80	40	9.73	6.1×10^3	7.8×10^4	359	76.2	4.2
12BFGH*90	90	40	8.37	8.1×10^3	1×10^5	359	76.2	4.2
12BFGH*100	100	40	6.88	1.1×10^3	1.4×10^5	359	76.2	4.2
12AKGH*112	112	20	5.25	1.5×10^4	1.9×10^5	359	76.2	4.3
12AKGH*125	125	20	4.92	2.1×10^4	2.4×10^5	359	76.2	4.3
Full Range								
12FFGN4910	10	40	90.6	2.7×10^2	4.7×10^3	359	76.2	4.1
12FFGN4916	16	40	69.1	4.2×10^2	6.1×10^3	359	76.2	4.1
12FFGN4920	20	40	45.8	9.5×10^2	1.1×10^4	359	76.2	4.1
12FFGN4925	25	40	36.5	1.6×10^3	1.5×10^4	359	76.2	4.1
12FFGN4931.5	31.5	40	25.4	3.1×10^3	2.5×10^4	359	76.2	4.1
12FFGN4940	40	40	19.7	4.7×10^3	3.8×10^4	359	76.2	4.1
12FFGN4950	50	40	14.7	8.4×10^3	5.6×10^4	359	76.2	4.1
12FFGN4963	63	40	12.6	6.3×10^3	5.4×10^4	359	76.2	4.1

* The fifth letter or number of the part reference denotes the end fixing arrangement.

There are a wide variety of end terminations available, the most popular types, some of which have dimensional references to BS2692: Part 1, are:

ADFH***C** Special offset tags, two hole fixings for Brush fuse switch equipment , BS Ref TA3
 ADFH***F** Offset tags two bolt fixing
 AFFH***D** Special offset tags, two hole fixings for Brush fuse switch equipment , BS Ref TA3
 AFFH***F** Offset tags two bolt fixing
 AKGH***D** Special offset tags, two hole fixings for Brush fuse switch equipment , BS Ref TA3
 AKGH***A** No tags - Ferrule - BS Ref. FA3 ADIHA / BS Ref FA4 AFIHA / BS Ref FA5 - AFKHA
 AKGH***F** Offset tags two bolt fixing
 BDGH***C** Special offset tags, two hole fixings for Brush fuse switch equipment , BS Ref TA3
 BDGH***A** No tags - Ferrule - BS Ref. FA3 ADIHA / BS Ref FA4 AFIHA / BS Ref FA5 - AFKHA
 BDGH***F** Offset tags two bolt fixing
 BFGH***A** No tags - Ferrule - BS Ref. FA3 ADIHA / BS Ref FA4 AFIHA / BS Ref FA5 - AFKHA
 BFGH***F** Offset tags two bolt fixing
 FFGN49: **49** Centre tags, single bolt fixing for use in Fused End Boxes

See previous page for outline drawings and dimensions.

Other tag variants available please consult Cooper Bussmann application engineers.

15.5kV - British Standard Air Fuse Links

Specifications

Description: Air fuse links

Ratings:

Rated Voltage: 15.5kV
 Rated Current: 6.3 - 85A
 Breaking Capacity: 20 - 40kA

Agency Information: comply with BS 2962-1 dimensions

Time-Current Curves and Cut-Off Curves: see list page 121 and data on CD at the back of the catalogue.

Dimensions (mm):

Tags Type	Code	A	B	C	D ϕ
A	BDGHA	359	N/A	N/A	51
	BFGHA	359	N/A	N/A	76
C & D	BDGHC	461	419	359	51
	BFGHD	461	419	349	76
F	BDGHF	461	419	359	51
	BFGHF	461	419	359	76



Features and Benefits

- Cool running, low watts loss and power dissipation thanks to the M-effect ensuring high levels of substation utilisation
- Silver elements ensuring high conductivity and low power (revenue) loss
- 100% X-ray, all our Medium Voltage fuse links are X-rayed ensuring the highest possible standards are maintained

Typical Applications

- Primary side transformer protection
- Used in fuse switch combination unit
- Used in fuse bases
- Used in fuse switches

A Tags

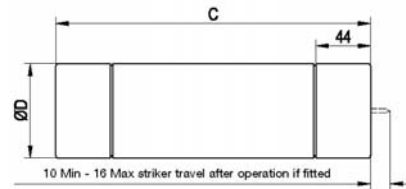

F Tags

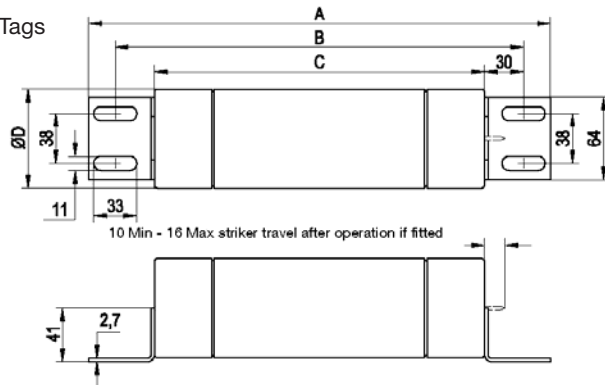

C & D Tags

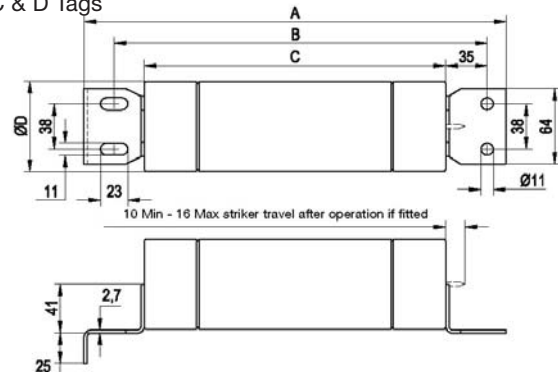

Part Numbers

Part Number	Rated Current I_n (A)	Breaking Capacity I_1 (kA)	Cold Resistance m Ω	Joule Integral (I^2t)		Length mm	Diameter mm	Weight kg
				Minimum Pre-Arcing	Maximum Operating			
15.5BDGH*6.3	6.3	20	485	4.8×10^1	8.5×10^2	359	50.8	2.1
15.5BDGH*10	10	20	158	7.2×10^1	1.2×10^3	359	50.8	2.1
15.5BDGH*16	16	20	99.1	7.2×10^1	1.2×10^3	359	50.8	2.1
15.5BDGH*20	20	20	74.6	1.3×10^2	2.8×10^3	359	50.8	2.1
15.5BDGH*25	25	20	54.2	2.4×10^2	4.3×10^3	359	50.8	2.1
15.5BDGH*31.5	31.5	20	38.2	4.9×10^2	7×10^3	359	50.8	2.1
15.5BDGH*40	40	20	27.2	9.6×10^2	1.2×10^4	359	50.8	2.1
15.5BFGH*50	50	20	22.2	1.6×10^3	3.2×10^4	359	76.2	4.2
15.5BFGH*63	63	20	15.5	3.2×10^3	4.6×10^4	359	76.2	4.2
15.5BFGH*80	80	20	9.73	7.2×10^3	1×10^5	359	76.2	4.2
15.5BFGH*85	85	20	9.45	7.2×10^3	1×10^5	359	76.2	4.2

* The fifth letter or number of the part reference denotes the end fixing arrangement.

There are a wide variety of end terminations available, the most popular types, some of which have dimensional references to BS2692: Part 1, are:

BDGHC: C Special offset tags, two hole fixings for Brush fuse switch equipment, BS Ref TA3

BDGHA: A No tags - Ferrule - BS Ref. FA3 ADIHA / BS Ref FA4 AFIHA / BS Ref FA5 - AFKHA

BDGHF: F Offset tags two bolt fixing

BFGHA: A No tags - Ferrule - BS Ref. FA3 ADIHA / BS Ref FA4 AFIHA / BS Ref FA5 - AFKHA

BFGHF: F Offset tags two bolt fixing

Other tag variants available please consult Cooper Bussmann application engineers.

24kV - British Standard Air Fuse Links

Specifications

Description: Air fuse links

Ratings:

Rated Voltage: 24kV

Rated Current: 6.3 - 90A

Breaking Capacity: 12 - 35.5kA

Agency Information: comply with BS 2962-1 dimensions

Time-Current Curves and Cut-Off Curves: see list page 121 and data on CD at the back of the catalogue.

Dimensions (mm):

Tags Type	Code	A	Dø
A	ADIHA	565	51
	FDIHA	565	51
	AFIHA	565	76

A Tags

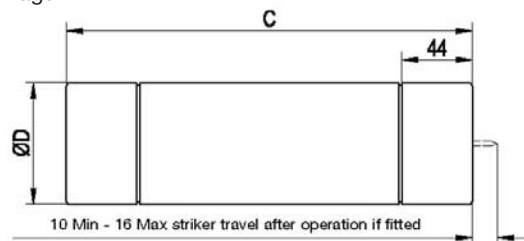

Features and Benefits

- *Cool running, low watts loss and power dissipation* thanks to the M-effect ensuring high levels of substation utilisation
- *Silver elements* ensuring high conductivity and low power (revenue) loss
- *100% X-ray*, all our Medium Voltage fuse links are X-rayed ensuring the highest possible standards are maintained

Typical Applications

- Primary side transformer protection
- Used in fuse switch combination unit
- Used in fuse bases
- Used in fuse switches

Part Numbers

Part Number	Rated Current I_n (A)	Breaking Capacity I_1 (kA)	Cold Resistance mΩ	Joule Integral (I^2t)		Length mm	Diameter mm	Weight kg
				Minimum Pre-Arcing	Maximum Operating			
24ADIHA6.3	6.3	12	520	7.9×10^1	8.5×10^2	565	50.8	3
24ADIHA10	10	12	173	7.2×10^1	1.1×10^2	565	50.8	3
24ADIHA16	16	12	129	1.3×10^2	1.7×10^3	565	50.8	3
24ADIHA20	20	12	104	2×10^2	2.8×10^3	565	50.8	3
24ADIHA25	25	12	82.7	3.1×10^2	4.1×10^3	565	50.8	3
24ADIHA31.5	31.5	12	66.2	4.9×10^2	6.8×10^3	565	50.8	3
24AFIHA40	40	16	46.5	1.2×10^3	1.1×10^4	565	76.2	6.1
24AFIHA50	50	16	33.2	2.4×10^3	2.2×10^4	565	76.2	6.1
24AFIHA63	63	16	23.5	3.2×10^3	5.2×10^4	565	76.2	6.1
24AFIHA80	80	16	17.9	5.5×10^3	8.2×10^4	565	76.2	6.1
24AFIHA90	90	16	14.7	7.2×10^3	1×10^5	565	76.2	6.1
Full Range								
24FDIHA3.15	3.15	35.5	893	3.1×10^1	9.8×10^1	565	50.8	3
24FDIHA5	5	35.5	412	5.9×10^1	4.5×10^2	565	50.8	3
24FDIHA6.3	6.3	35.5	412	5.9×10^1	4.5×10^2	565	50.8	3
24FDIHA10	10	35.5	205	2.7×10^2	2.1×10^3	565	50.8	3
24FDIHA16	16	35.5	103	1.1×10^3	8.3×10^3	565	50.8	3
24FDIHA20	20	35.5	88.2	1.3×10^3	4.8×10^3	565	50.8	3
24FDIHA31.5	31.5	35.5	56	5.3×10^3	2×10^4	565	50.8	3

Notes:

There are a wide variety of end terminations available, the most popular types, some of which have dimensional references to BS2692: Part 1, are:
 ADIHA: A No tags - Ferrule - BS Ref. FA3 ADIHA / BS Ref FA4 AFIHA / BS Ref FA5 - AFKHA
 AFIHA: A No tags - Ferrule - BS Ref. FA3 ADIHA / BS Ref FA4 AFIHA / BS Ref FA5 - AFKHA
 FDIHA: A No tags - Ferrule - BS Ref. FA3 ADIHA / BS Ref FA4 AFIHA / BS Ref FA5 - AFKHA
 Other tag variants available please consult Cooper Bussmann application engineers.

36kV - British Standard Air Fuse Links

Specifications

Description: Air fuse links

Ratings:

Rated Voltage: 36kV
 Rated Current: 3.15 - 71A
 Breaking Capacity: 12 - 35.5kA

Agency Information: comply with BS 2962-1 dimensions

Time-Current Curves and Cut-Off Curves: see list page 121 and data on CD at the back of the catalogue.

Dimensions (mm):

Tags Type	Code	A	Dø
A	ADIHA	565	51
	AFIHA	565	76
	AFKHA	914	76

A Tags

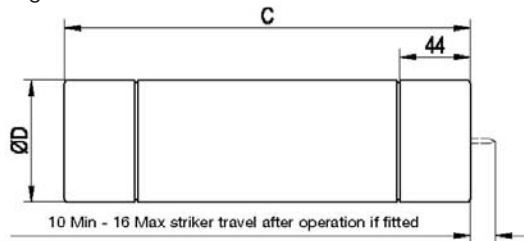

Features and Benefits

- *Cool running, low watts loss and power dissipation* thanks to the M-effect ensuring high levels of substation utilisation
- *Silver elements* ensuring high conductivity and low power (revenue) loss
- *100% X-ray*, all our Medium Voltage fuse links are X-rayed ensuring the highest possible standards are maintained

Typical Applications

- Primary side transformer protection
- Used in fuse switch combination unit
- Used in fuse bases
- Used in fuse switches

Part Numbers

Part Number	Rated Current I_n (A)	Breaking Capacity I_1 (kA)	Cold Resistance $m\Omega$	Joule Integral (I^2t)		Length mm	Diameter mm	Weight kg
				Minimum Pre-Arcing	Maximum Operating			
36ADIHA3.15	3.15	16	1460	2×10^1	2.5×10^2	565	50.8	3
36ADIHA5	5	16	973	4.4×10^1	5.5×10^2	565	50.8	3
36ADIHA6-3	6.3	16	781	7.1×10^1	8.9×10^2	565	50.8	3
36ADIHA10	10	16	378	7.2×10^1	1.1×10^3	565	50.8	3
36ADIHA16	16	16	190	1.1×10^2	1.7×10^3	565	50.8	3
36ADIHA20	20	16	142	2×10^2	2.8×10^3	565	50.8	3
36ADIHA25	25	16	115	3.1×10^2	4.5×10^3	565	50.8	3
36ADIHA31.5	31.5	16	81.5	6.1×10^2	8.1×10^3	565	50.8	3
36AFIHA40	40	25	61.5	1.2×10^3	1.9×10^4	565	76.2	6.1
36AFKHA50	50	25	54.5	1.9×10^3	2.8×10^4	914	76.2	9.7
36AFKHA63	63	25	40.6	3.5×10^3	5×10^4	914	76.2	9.7
36AFKHA71	71	25	32.5	5.5×10^3	8.2×10^4	914	76.2	9.7

Notes:

There are a wide variety of end terminations available, the most popular types, some of which have dimensional references to BS2692: Part 1, are:

ADIHA: A No tags - Ferrule - BS Ref. FA3 ADIHA / BS Ref FA4 AFIHA / BS Ref FA5 - AFKHA
 AFIHA: A No tags - Ferrule - BS Ref. FA3 ADIHA / BS Ref FA4 AFIHA / BS Ref FA5 - AFKHA
 AFKHA: A No tags - Ferrule - BS Ref. FA3 ADIHA / BS Ref FA4 AFIHA / BS Ref FA5 - AFKHA

See previous page for outline drawings and dimensions.

Other tag variants available please consult Cooper Bussmann application engineers.

72.5kV - British Standard Air Fuse Links

Specifications

Description: Air fuse links

Ratings:

Rated Voltage: 72.5kV
 Rated Current: 3.15 - 40A
 Breaking Capacity: 12kA

Agency Information: comply with BS 2962-1 dimensions

Time-Current Curves and Cut-Off Curves: see list page 121 and data on CD at the back of the catalogue.

Dimensions (mm):

Tags Type	Code	A	Dø
A	AFKHA	914	76

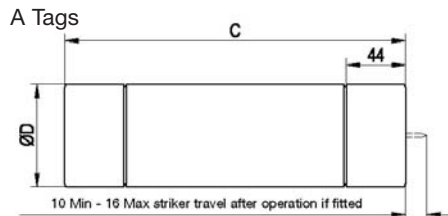

Features and Benefits

- *Cool running, low watts loss and power dissipation* thanks to the M-effect ensuring high levels of substation utilisation
- *Silver elements* ensuring high conductivity and low power (revenue) loss
- *100% X-ray*, all our Medium Voltage fuse links are X-rayed ensuring the highest possible standards are maintained

Typical Applications

- Primary side transformer protection
- Used in fuse bases

Part Numbers

Part Number	Rated Current I_n (A)	Breaking Capacity I_1 (kA)	Cold Resistance mΩ	Joule Integral (I^2t)		Length mm	Diameter mm	Weight kg
				Minimum Pre-Arcing	Maximum Operating			
72.5AFKHA3.15	3.15	12	4230	1.4×10^1	1.8×10^2	914	76.2	9.7
72.5AFKHA5	5	12	1600	1.1×10^2	1.4×10^3	914	76.2	9.7
72.5AFKHA6.3	6.3	12	1200	1.9×10^2	2.5×10^3	914	76.2	9.7
72.5AFKHA10	10	12	519	7.2×10^1	9.3×10^2	914	76.2	9.7
72.5AFKHA16	16	12	389	1.3×10^2	1.7×10^3	914	76.2	9.7
72.5AFKHA20	20	12	249	3.1×10^2	4×10^3	914	76.2	9.7
72.5AFKHA25	25	12	195	5.1×10^2	6.6×10^3	914	76.2	9.7
72.5AFKHA31.5	31.5	12	130	1×10^3	1.3×10^4	914	76.2	9.7
72.5AFKHA40	40	12	92.7	2×10^3	2.6×10^4	914	76.2	9.7

The fifth letter or number of the part reference denotes the end fixing arrangement.

There are a wide variety of end terminations available, the most popular types, some of which have dimensional references to BS2692: Part 1, are:

AFKHA: A No tags - Ferrule - BS Ref. FA3 ADIHA / BS Ref FA4 AFIHA / BS Ref FA5 - AFKHA

Other tag variants available please consult Cooper Bussmann application engineers.

US Style E-Rated Medium Voltage Fuse Links

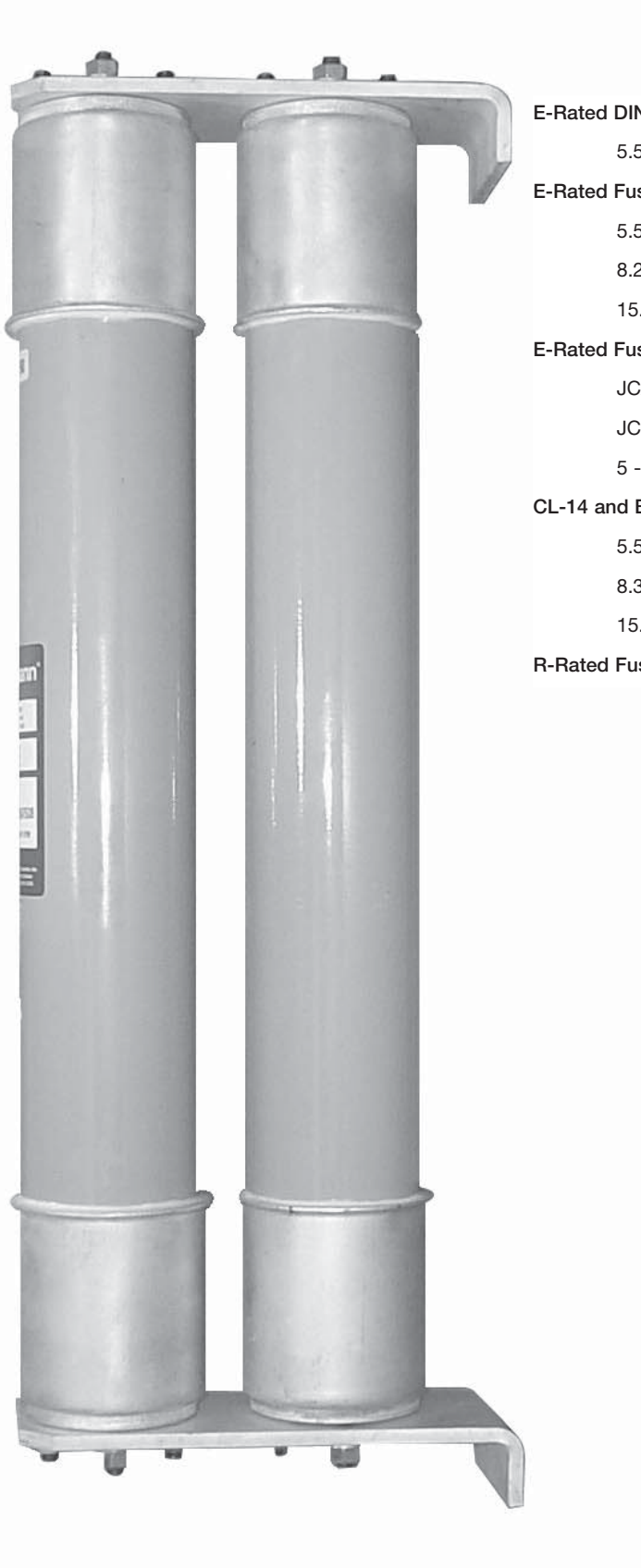

- E-Rated DIN Fuse Links**
 - 5.5kV to 38kV..... 77 - 78
- E-Rated Fuse Links for Transformers and Feeder Protection**
 - 5.5kV..... 79 - 80
 - 8.25kV..... 81
 - 15.5kV..... 82 - 83
- E-Rated Fuse Links for Potential and Small Power Transformers**
 - JCX, JCY, JCU, JCZ and JDZ..... 84 - 85
 - JCD, JCW, JCE, JCQ, JCI and JCT..... 86
 - 5 - 38kV..... 87
- CL-14 and Bolt-In**
 - 5.5kV..... 88
 - 8.3kV..... 89
 - 15.5kV..... 90
- R-Rated Fuse Links for Motor Circuit Protection..... 91 - 93**

5.5kV to 38kV E-Rated DIN Fuse Links

Specifications

Description: DIN dimensional E-Rated power fuse links with striker fitted for indoor use.

Agency: Meets E requirements per ANSI C37.46, meets General Purpose and Full Range requirements per ANSI C37.40.

Ratings:

Rated Voltage: 5.5 - 38kV

Rated Current: 10 - 450E

IR: 25 - 65kA

Time-Current Curves and Cut-Off Curves: see list page 121 and data on CD at the back of the catalogue.

Dimensions:

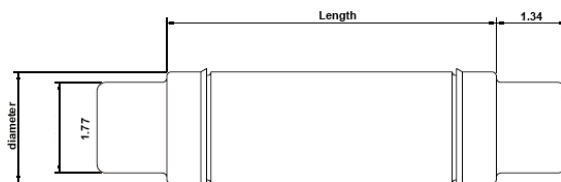

Features and Benefits:

- *Cool running, low watts loss and power dissipation* thanks to the M-effect ensuring high levels of substation utilisation
- *100% X-ray*, all our Medium Voltage fuse links are X-rayed ensuring the highest possible standards are maintained

Typical Applications:

- Medium voltage transformer primary protection.
- Medium voltage feeder circuit protection.

Part Numbers

Part Number	Rated Current	Interrupting Capacity Sym kA	Number of Barrels	Length inches (mm)	Diameter inches (mm)
5.5kV General Purpose					
55GDMSJ10E	10E	65	1	17.40 (442)	2 (51)
55GDMSJ15E	15E	65	1	17.40 (442)	2 (51)
55GDMSJ20E	20E	65	1	17.40 (442)	2 (51)
55GDMSJ25E	25E	65	1	17.40 (442)	2 (51)
55GDMSJ30E	30E	65	1	17.40 (442)	2 (51)
55GDMSJ40E	40E	65	1	17.40 (442)	2 (51)
55GDMSJ50E	50E	65	1	17.40 (442)	2 (51)
55GDMSJ65E	65E	65	1	17.40 (442)	2 (51)
55GDMSJ80E	80E	65	1	17.40 (442)	2 (51)
55GDMSJ100E	100E	65	1	17.40 (442)	2 (51)
55GDMSJ125E	125E	65	1	17.40 (442)	2 (51)
55GFMSJ150E	150E	65	1	17.40 (442)	3 (76)
55GFMSJ175E	175E	65	1	17.40 (442)	3 (76)
55GFMSJ200E	200E	65	1	17.40 (442)	3 (76)
55GFMSJ250E	250E	65	1	17.40 (442)	3 (76)
55GFMSJ300E	300E	65	1	17.40 (442)	3 (76)
55GFMSJ350E	350E	65	1	17.40 (442)	3 (76)
55GFMSJ400E	400E	65	1	17.40 (442)	3 (76)
55GFMSJ450E	450E	65	1	17.40 (442)	3 (76)
15.5kV General Purpose					
155GXQSJ175E	175E	65	1	21.14 (537)	3.5 (88)
155GXQSJ200E	200E	65	1	21.14 (537)	3.5 (88)

5.5kV to 38kV E-Rated DIN Fuse Links

Part Numbers

Part Number	Rated Current	Interrupting Capacity Sym kA	Number of Barrels	Length inches (mm)	Diameter inches (mm)
17.5kV General Purpose					
175GDMSJ10E	10E	65	1	17.40 (442)	2 (51)
175GDMSJ15E	15E	65	1	17.40 (442)	2 (51)
175GDMSJ20E	20E	65	1	17.40 (442)	2 (51)
175GDMSJ25E	25E	65	1	17.40 (442)	2 (51)
175GDMSJ30E	30E	65	1	17.40 (442)	2 (51)
175GFMSJ40E	40E	65	1	17.40 (442)	3 (76)
175GFMSJ50E	50E	65	1	17.40 (442)	3 (76)
175GFMSJ65E	65E	65	1	17.40 (442)	3 (76)
175GXMSJ80E	80E	65	1	17.40 (442)	3.5 (88)
175GXMSJ100E	100E	65	1	17.40 (442)	3.5 (88)
175GXQSJ125E	125E	65	1	21.14 (537)	3.5 (88)
175GXQSJ150E	150E	65	1	21.14 (537)	3.5 (88)
25.8kV Full Range					
258GDQSJ10E	10E	25	1	21.14 (537)	2 (51)
258GDQSJ15E	15E	25	1	21.14 (537)	2 (51)
258GDQSJ20E	20E	25	1	21.14 (537)	2 (51)
258GDQSJ25E	25E	25	1	21.14 (537)	2 (51)
258GDQSJ30E	30E	25	1	21.14 (537)	2 (51)
258GXQSJ40E	40E	25	1	21.14 (537)	3.46 (88)
258GXQSJ50E	50E	25	1	21.14 (537)	3.46 (88)
258GXQSJ65E	65E	25	1	21.14 (537)	3.46 (88)
258GXZSJ80E	80E	25	1	28.03 (712)	3.46 (88)
258GXZSJ100E	100E	25	1	28.03 (712)	3.46 (88)
38kV Full Range					
38GFZSJ10E	10E	25	1	28.03 (712)	3 (76)
38GFZSJ15E	15E	25	1	28.03 (712)	3 (76)
38GFZSJ20E	20E	25	1	28.03 (712)	3 (76)
38GFZSJ25E	25E	25	1	28.03 (712)	3 (76)
38GFZSJ30E	30E	25	1	28.03 (712)	3 (76)
38GXZSJ40E	40E	25	1	28.03 (712)	3.46 (88)
38GXZSJ50E	50E	25	1	28.03 (712)	3.46 (88)
38GXZSJ65E	65E	25	1	28.03 (712)	3.46 (88)

5.5kV E-Rated Fuse Links for Transformers and Feeder protection

Specifications

Description: E-Rated power fuse links having full range clearing capability for medium voltage transformer circuit protection.

Ratings:

Rated Voltage: 5.5kV

Rated Current: 5 - 450E

IR: 50kA

Time-Current Curves and Cut-Off Curves: see list page 121 and data on CD at the back of the catalogue.

Dimensions: See outline drawings below and part numbers page 80.



Features and Benefits:

- *Cool running, low watts loss and power dissipation* thanks to the M-effect ensuring high levels of substation utilisation
- *100% X-ray*, all our Medium Voltage fuse links are X-rayed ensuring the highest possible standards are maintained

Typical Applications:

- Medium voltage transformer primary protection.
- Medium voltage feeder circuit protection.

MV055F1CAX

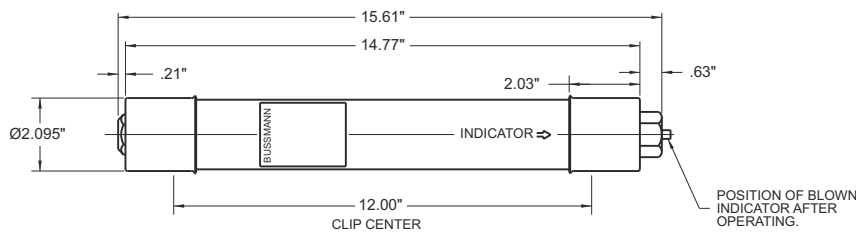

MV055F1DAX

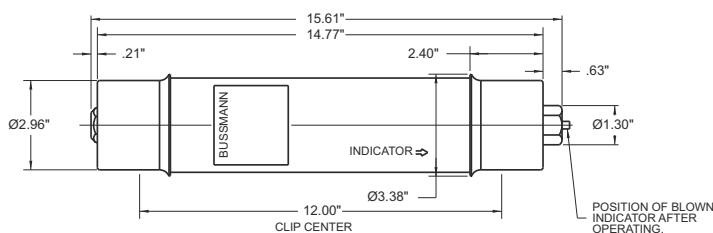

Double Barrel Dimensions

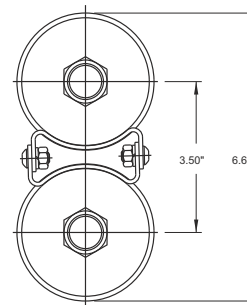

5.5kV E-Rated Fuse Links for Transformers and Feeder protection

Part Numbers

Part Number	Rated Current	Interrupting Capacity Sym kA	Number of Barrels	Length inches (mm)	Diameter inches (mm)	Clip Center inches (mm)
5.5FFNHA30E	30E	50	1	15.87 (403)	3 (76)	12 (304)
5.5FFNHA40E	40E	50	1	15.87 (403)	3 (76)	12 (304)
5.5FFNHA50E	50E	50	1	15.87 (403)	3 (76)	12 (304)
5.5FFNHA65E	60E	50	1	15.87 (403)	3 (76)	12 (304)
5.5FFNHA75E	75E	50	1	15.87 (403)	3 (76)	12 (304)
5.5FFNHK100E	100E	50	2	15.87 (403)	3 (76)	12 (304)
5.5FFNHK150E	150E	50	2	15.87 (403)	3 (76)	12 (304)
5.5BFNHA80*	80A	50	1	15.87 (403)	3 (76)	12 (304)
5.5BFNHA100*	100A	50	1	15.87 (403)	3 (76)	12 (304)
5.5BFNHA150*	150A	50	1	15.87 (403)	3 (76)	12 (304)
5.5BKNHA200*	200A	50	1	15.87 (403)	3 (76)	12 (304)
5.5BFNHK250*	250A	50	2	15.87 (403)	3 (76)	12 (304)
5.5BFNHK300*	300A	50	2	15.87 (403)	3 (76)	12 (304)
5.5BFNHK400*	400A	50	2	15.87 (403)	3 (76)	12 (304)
MV055F1CAX5E	5E	50	1	15.75 (400)	2 (50)	12 (304)
MV055F1CAX7E	7E	50	1	15.75 (400)	2 (50)	12 (304)
MV055F1CAX10E	10E	50	1	15.75 (400)	2 (50)	12 (304)
MV055F1CAX15E	15E	50	1	15.75 (400)	2 (50)	12 (304)
MV055F1CAX20E	20E	50	1	15.75 (400)	2 (50)	12 (304)
MV055F1CAX25E	25E	50	1	15.75 (400)	2 (50)	12 (304)
MV055F1CAX30E	30E	50	1	15.75 (400)	2 (50)	12 (304)
MV055F1CAX40E	40E	50	1	15.75 (400)	2 (50)	12 (304)
MV055F1CAX50E	50E	50	1	15.75 (400)	2 (50)	12 (304)
MV055F1CAX65E	65E	50	1	15.75 (400)	2 (50)	12 (304)
MV055F1DAX10E	10E	50	1	15.75 (400)	3 (76)	12 (304)
MV055F1DAX15E	15E	50	1	15.75 (400)	3 (76)	12 (304)
MV055F1DAX20E	20E	50	1	15.75 (400)	3 (76)	12 (304)
MV055F1DAX25E	25E	50	1	15.75 (400)	3 (76)	12 (304)
MV055F1DAX80E	80E	50	1	15.75 (400)	3 (76)	12 (304)
MV055F1DAX125E	125E	50	1	15.75 (400)	3 (76)	12 (304)
MV055F1DAX175E	175E	50	1	15.75 (400)	3 (76)	12 (304)
MV055F1DAX200E	200E	50	1	15.75 (400)	3 (76)	12 (304)
MV055F2DAX250E	250E	50	2	15.75 (400)	3 (76)	12 (304)
MV055F2DAX300E	300E	50	2	15.75 (400)	3 (76)	12 (304)
MV055F2DAX350E	350E	50	2	15.75 (400)	3 (76)	12 (304)
MV055F2DAX400E	400E	50	2	15.75 (400)	3 (76)	12 (304)
MV055F2DAX450E	450E	50	2	15.75 (400)	3 (76)	12 (304)

* These ratings are classed as back-up fuse links

8.25kV E-Rated Fuse Links for Transformers and Feeder Protection

Specifications

Description: E-Rated power fuse links having full range clearing capability for medium voltage transformer circuit protection.

Ratings:

Rated Voltage: 8.25kV
 Rated Current: 80 - 200A, 20 - 150E
 IR: 50kA

Time-Current Curves and Cut-Off Curves: see list page 121 and data on CD at the back of the catalogue.



Features and Benefits:

- *Cool running, low watts loss and power dissipation* thanks to the M-effect ensuring high levels of substation utilisation
- *100% X-ray*, all our Medium Voltage fuse links are X-rayed ensuring the highest possible standards are maintained

Typical Applications:

- Medium voltage transformer primary protection.
- Medium voltage feeder circuit protection.

Part Numbers

Part Number	Rated Current	Interrupting Capacity Sym kA	Number of Barrels	Length inches (mm)	Diameter inches (mm)	Clip Center inches (mm)
8.25FFNHA20E	20E	50	1	15.87 (403)	3 (76)	12 (304)
8.25FFNHA25E	25E	50	1	15.87 (403)	3 (76)	12 (304)
8.25FFNHA30E	30E	50	1	15.87 (403)	3 (76)	12 (304)
8.25FFNHA40E	40E	50	1	15.87 (403)	3 (76)	12 (304)
8.25FFNHA50E	50E	50	1	15.87 (403)	3 (76)	12 (304)
8.25FFNHA65E	65E	50	1	15.87 (403)	3 (76)	12 (304)
8.25FFNHA75E	75E	50	1	15.87(403)	3 (76)	12 (304)
8.25FFNHK100E	100E	50	2	15.87 (403)	3 (76)	12 (304)
8.25FFNHK150E	150E	50	2	15.87 (403)	3 (76)	12 (304)
8.25BFNHA80*	80A	50	1	15.87 (403)	3 (76)	12 (304)
8.25BFNHA100*	100A	50	1	15.87 (403)	3 (76)	12 (304)
8.25BFNHA150*	150A	50	2	15.87 (403)	3 (76)	12 (304)
8.25BFNHA200*	200A	50	2	15.87 (403)	3 (76)	12 (304)

* These ratings are classed as Back-up fuses

15.5kV E-Rated Fuse Links for Transformers and Feeder Protection

Specifications

Description: E-Rated power fuse links having full range clearing capability for medium voltage transformer circuit protection.

Ratings:

Rated Voltage: 15.5kV
 Rated Current: 5 - 200E
 IR: 50kA

Time-Current Curves and Cut-Off Curves: see list page 121 and data on CD at the back of the catalogue.

Dimensions: See outline drawings below and part numbers table opposite page.



Features and Benefits:

- Cool running, low watts loss and power dissipation thanks to the M-effect ensuring high levels of substation utilisation
- 100% X-ray, all our Medium Voltage fuse links are X-rayed ensuring the highest possible standards are maintained

Typical Applications:

- Medium voltage transformer primary protection.
- Medium voltage feeder circuit protection.

MV155F1CBX

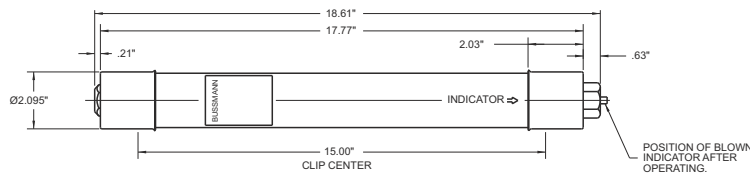

MV155F1DBX

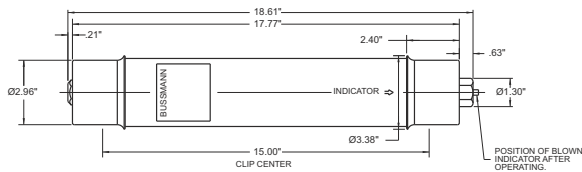

MV155F1DCX

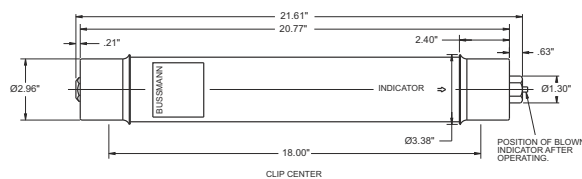

Double Barrel Dimensions

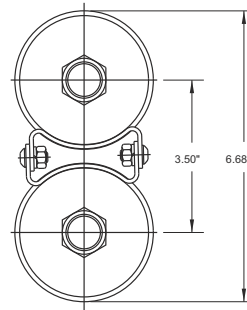

15.5kV E-rated Fuse Links for Transformers and Feeder Protection

Part Numbers

Part Number	Rated Current	Interrupting Capacity Sym kA	Number of Barrels	Length inches (mm)	Diameter inches (mm)	Clip Center inches (mm)
15.5FFVHA15E	15E	50	1	18.86 (479)	3 (76)	15
15.5FFVHA20E	20E	50	1	18.86 (479)	3 (76)	15
15.5FFVHA25E	25E	50	1	18.86 (479)	3 (76)	15
15.5FFVHA30E	30E	50	1	18.86 (479)	3 (76)	15
15.5FFVHA40E	40E	50	1	18.86 (479)	3 (76)	15
15.5FFVHA50E	50E	50	1	18.86 (479)	3 (76)	15
15.5FFVHA65E	65E	50	1	18.86 (479)	3 (76)	15
15.5FFVHA75E	75E	50	1	18.86 (479)	3 (76)	15
15.5FFVHK100E	100E	50	2	18.86 (479)	3 (76)	15
15.5FFVHK150E	150E	50	2	18.86 (479)	3 (76)	15
MV155F1CBX5E	5E	50	1	18.75 (476)	2 (50)	15
MV155F1CBX7E	7E	50	1	18.75 (476)	2 (50)	15
MV155F1CBX10E	10E	50	1	18.75 (476)	2 (50)	15
MV155F1CBX15E	15E	50	1	18.75 (476)	2 (50)	15
MV155F1CBX20E	20E	50	1	18.75 (476)	2 (50)	15
MV155F1CBX25E	25E	50	1	18.75 (476)	2 (50)	15
MV155F1CBX30E	30E	50	1	18.75 (476)	2 (50)	15
MV155F1DBX10E	10E	50	1	18.75 (476)	3 (76)	15
MV155F1DBX80E	80E	50	1	18.75 (476)	3 (76)	15
MV155F1DBX100E	100E	50	1	18.75 (476)	3 (76)	15
MV155F2DBX125E	125E	50	2	18.75 (476)	3 (76)	15
MV155F2DBX175E	175E	50	2	18.75 (476)	3 (76)	15
MV155F2DBX200E	200E	50	2	18.75 (476)	3 (76)	15
MV155F1DCX65E	65E	50	1	21.75 (552)	3 (76)	18
MV155F1DCX80E	80E	50	1	21.75 (552)	3 (76)	18
MV155F1DCX100E	100E	50	1	21.75 (552)	3 (76)	18
MV155F2DCX125E	125E	50	2	21.75 (552)	3 (76)	18
MV155F2DCX150E	150E	50	2	21.75 (552)	3 (76)	18
MV155F2DCX175E	175E	50	2	21.75 (552)	3 (76)	18
MV155F2DCX200E	200E	50	2	21.75 (552)	3 (76)	18

JCX, JCY, JCU, JCZ and JDZ E-Rated Fuse Links for Potential and Small Power Transformers

Specifications

Description: Indoor/enclosure E-rated medium voltage, current-limiting fuse links for potential & small power transformers with blown fuse link indication.

Ratings:

Rated Voltage: 2.4 - 8.3kV

Rated Current: ½ - 750A

Breaking Capacity: 40 - 63kA Sym



Features and Benefits:

- Physically dimensioned for retrofitting in existing hardware
- Open fuse indicator for ease in troubleshooting
- Full range ANSI classification

Typical Applications:

- Medium voltage transformer primary protection
- Medium voltage feeder circuit protection
- Medium voltage switches
- Medium voltage metal-enclosed switchgear

Part Numbers

Part Number	Rated Voltage	Rated Current	Interrupting Capacity Sym kA	Number of Barrels	Length inches (mm)	Diameter inches (mm)
JCX-½E	2.4kV	0.5E	40	1	9.19 (233)	2 (51)
JCX-1E	2.4kV	1E	40	1	9.19 (233)	2 (51)
JCX-2E	2.4kV	2E	40	1	9.19 (233)	2 (51)
JCX-3E	2.4kV	3E	40	1	9.19 (233)	2 (51)
JCX-5E	2.4kV	5E	40	1	9.19 (233)	2 (51)
JCX-7E	2.4kV	7E	40	1	9.19 (233)	2 (51)
JCX-10E	2.4kV	10E	40	1	9.19 (233)	2 (51)
JCX-15E	2.4kV	15E	50	1	9.50 (241)	2.1 (53)
JCX-20E	2.4kV	20E	50	1	9.50 (241)	2.1 (53)
JCX-25E	2.4kV	25E	50	1	9.50 (241)	2.1 (53)
JCX-30E	2.4kV	30E	50	1	10.88 (276)	3 (76)
JCX-40E	2.4kV	40E	50	1	10.88 (276)	3 (76)
JCX-50E	2.4kV	50E	50	1	10.88 (276)	3 (76)
JCX-65E	2.4kV	65E	50	1	10.88 (276)	3 (76)
JCX-80E	2.4kV	80E	50	1	10.88 (276)	3 (76)
JCX-100E	2.4kV	100E	50	1	10.88 (276)	3 (76)
JCX-125E	2.4kV	125E	50	1	10.88 (276)	3 (76)
JCX-150E	2.4kV	150E	50	1	10.88 (276)	3 (76)
JCX-200E	2.4kV	200E	50	1	10.88 (276)	3 (76)
JCX-225E	2.4kV	225E	50	1	10.88 (276)	3 (76)
JCX-250E/280X	2.4kV	250E	50	1	10.88 (276)	3 (76)
JCX-300E/325X	2.4kV	300E	50	1	10.88 (276)	3 (76)
JCX-350E	2.4kV	350E	50	1	10.88 (276)	3 (76)
JCX-400X	2.4kV	400X	50	1	10.88 (276)	3 (76)
JCX-450X	2.4kV	450X	50	1	10.88 (276)	3 (76)

JCX, JCY, JCU, JCZ and JDZ E-Rated Fuse Links for Potential and Small Power Transformers

Part Number	Rated Voltage	Rated Current	Interrupting Capacity Sym	Number of Barrels	Length inches (mm)	Diameter inches (mm)
JCY-½E	5.5kV	0.5E	40	1	11.19 (284)	2 (51)
JCY-1E	5.5kV	1E	40	1	11.19 (284)	2 (51)
JCY-2E	5.5kV	2E	40	1	11.19 (284)	2 (51)
JCY-3E	5.5kV	3E	40	1	11.19 (284)	2 (51)
JCY-5E	5.5kV	5E	40	1	11.19 (284)	2 (51)
JCY-7E	5.5kV	7E	40	1	11.19 (284)	2 (51)
JCY-10E	5.5kV	10E	40	1	11.19 (284)	2 (51)
JCY-15E	5.5kV	15E	40	1	11.19 (284)	2 (51)
JCY-20E	5.5kV	20E	40	1	11.19 (284)	2 (51)
JCY-25E	5.5kV	25E	40	1	11.19 (284)	2 (51)
JCU-10E	5.5kV	10E	50	1	17.81 (452)	3 (76)
JCU-15E	5.5kV	15E	50	1	12.87 (326)	2.1 (53)
JCU-20E	5.5kV	20E	50	1	12.87 (326)	2.1 (53)
JCU-25E	5.5kV	25E	50	1	12.87 (326)	2.1 (53)
JCU-30E	5.5kV	30E	63	1	17.88 (454)	3 (76)
JCU-40E	5.5kV	40E	63	1	17.88 (454)	3 (76)
JCU-50E	5.5kV	50E	63	1	17.88 (454)	3 (76)
JCU-65E	5.5kV	65E	63	1	17.88 (454)	3 (76)
JCU-80E	5.5kV	80E	63	1	17.88 (454)	3 (76)
JCU-100E	5.5kV	100E	63	1	17.88 (454)	3 (76)
JCU-125E	5.5kV	125E	63	1	17.88 (454)	3 (76)
JCU-150E	5.5kV	150E	63	1	17.88 (454)	3 (76)
JCU-175E	5.5kV	175E	63	1	17.88 (454)	3 (76)
JCU-200E	5.5kV	200E	63	1	17.88 (454)	3 (76)
JCU-250E	5.5kV	250E	63	1	17.88 (454)	3 (76)
JCU-300E	5.5kV	300E	63	1	17.88 (454)	3 (76)
JCU-350E	5.5kV	350E	63	1	17.88 (454)	3 (76)
JCU-400E	5.5kV	400E	63	1	17.88 (454)	3 (76)
JCU-450E	5.5kV	450E	63	1	17.88 (454)	3 (76)
JCU-600E	5.5kV	600E	50	1	28.81 (731)	4 (101)
JCU-750E	5.5kV	750E	50	1	28.81 (731)	4 (101)
JCZ-15E	8.3kV	15E	50	1	15.51 (393)	2.1 (53)
JCZ-20E	8.3kV	20E	50	1	15.51 (393)	2.1 (53)
JCZ-25E	8.3kV	25E	50	1	15.51 (393)	2.1 (53)
JCZ-30E	8.3kV	30E	50	1	17.88 (454)	3 (76)
JCZ-40E	8.3kV	40E	50	1	17.88 (454)	3 (76)
JCZ-50E	8.3kV	50E	50	1	17.88 (454)	3 (76)
JCZ-65E	8.3kV	65E	50	1	17.88 (454)	3 (76)
JCZ-80E	8.3kV	80E	50	1	17.88 (454)	3 (76)
JCZ-100E	8.3kV	100E	50	1	17.88 (454)	3 (76)
JCZ-125E	8.3kV	125E	50	1	17.88 (454)	3 (76)
JCZ-150E	8.3kV	150E	50	1	17.88 (454)	3 (76)
JCZ-200E	8.3kV	200E	50	1	17.88 (454)	3 (76)
JDZ-20E	8.3kV	20E	50	1	15.87 (403)	3 (76)
JDZ-25E	8.3kV	25E	50	1	15.87 (403)	3 (76)
JDZ-30E	8.3kV	30E	50	1	15.87 (403)	3 (76)
JDZ-40E	8.3kV	40E	50	1	15.87 (403)	3 (76)
JDZ-50E	8.3kV	50E	50	1	15.87 (403)	3 (76)
JDZ-65E	8.3kV	65E	50	1	15.87 (403)	3 (76)
JDZ-80E	8.3kV	80E	50	1	15.87 (403)	3 (76)
JDZ-100E	8.3kV	100E	50	1	15.87 (403)	3 (76)
JDZ-125E	8.3kV	125E	50	1	15.87 (403)	3 (76)

JCD, JCW, JCE, JCQ JCI, JCT E-Rated Fuse Links for Potential and Small Power Transformers

Specifications

Description: Indicating and non-indicating E-Rated medium voltage, current limiting fuse links for potential and small power transformers.

Ratings:

Rated Voltage: 2.4 - 15.5kV

Rated Current: ½ - 10A

Breaking Capacity: 25 - 80kA Sym

Typical Applications:

- Primary protection of medium voltage potential transformers.



Part Numbers

Part Number	Rated Voltage	Rated Current	Interrupting Capacity Sym kA	Number of Barrels	Length inches (mm)	Diameter inches (mm)
JCD-½E	2.4kV	0.5E	63	1	4.49 (114)	0.8 (20)
JCD-1E	2.4kV	1E	40	1	4.49 (114)	0.8 (20)
JCD-2E	2.4kV	2E	40	1	4.49 (114)	0.8 (20)
JCD-5E	2.4kV	5E	25	1	4.49 (114)	0.8 (20)
JCW-½E	2.4kV/5.5kV	0.5E	40	1	7.31 (185)	1.56 (39)
JCW-1E	2.4kV/5.5kV	1E	40	1	7.31 (185)	1.56 (39)
JCW-2E	2.4kV/5.5kV	2E	40	1	7.31 (185)	1.56 (39)
JCW-3E	2.4kV/5.5kV	3E	40	1	7.31 (185)	1.56 (39)
JCW-4E	2.4kV/5.5kV	4E	40	1	7.31 (185)	1.56 (39)
JCW-5E	2.4kV/5.5kV	5E	40	1	7.31 (185)	1.56 (39)
JCE-½E	5.5kV	0.5E	50	1	5.63 (143)	0.8 (20)
JCE-1E	5.5kV	1E	50	1	5.63 (143)	0.8 (20)
JCE-2E	5.5kV	2E	50	1	5.63 (143)	0.8 (20)
JCE-3E	5.5kV	3E	50	1	5.63 (143)	0.8 (20)
JCE-4E	5.5kV	4E	50	1	5.63 (143)	0.8 (20)
JCE-5E	5.5kV	5E	50	1	5.63 (143)	0.8 (20)
JCQ-½E	5.5kV	0.5E	80	1	9.50 (241)	1.6 (40)
JCQ-1E	5.5kV	1E	80	1	9.50 (241)	1.6 (40)
JCQ-1-½E	5.5kV	1.5E	80	1	9.50 (241)	1.6 (40)
JCQ-3E	5.5kV	3E	80	1	9.44 (239)	1.6 (40)
JCQ-5E	5.5kV	5E	80	1	9.44 (239)	1.6 (40)
JCQ-10E	5.5kV	10E	80	1	9.44 (239)	1.6 (40)
JCI-½E	8.3kV	0.5E	80	1	9.50 (241)	1.6 (40)
JCI-3E	8.3kV	3E	80	1	12.88 (327)	1.6 (40)
JCI-5E	8.3kV	5E	80	1	12.88 (327)	1.6 (40)
JCI-10E	8.3kV	10E	80	1	12.88 (327)	1.6 (40)
JCT-½E	15.5kV	0.5E	80	1	12.93 (328)	1.6 (40)
JCT-1E	15.5kV	1E	80	1	12.93 (328)	1.6 (40)
JCT-1-½E	15.5kV	1.5E	80	1	12.93 (328)	1.6 (40)
JCT-3E	15.5kV	3E	80	1	17.50 (444)	1.6 (40)
JCT-5E	15.5kV	5E	80	1	17.50 (444)	1.6 (40)
JCT-10E	15.5kV	10E	80	1	17.50 (444)	1.6 (40)

E-Rated Fuse Links for Potential and Small Power Transformers

Specifications

Description: Indicating and non-indicating E-Rated medium voltage, current-limiting fuses for potential and small power transformers.

Ratings:

Rated Voltage: 5 - 38kV (See part numbers table for details)

Rated Current: 0.5 - 7E

Breaking Capacity: 40 - 80kA

Time-Current Curves and Cut-Off Curves: see list page 121 and data on CD at the back of the catalogue.

Typical Applications:

- Primary protection of medium voltage potential transformers.



Part Numbers

Part Number	Rated Voltage	Rated Current	Interrupting Capacity Sym kA	Number of Barrels	Length inches (mm)	Diameter inches (mm)	Clipping Centres inches (mm)
5.5AMWNA0.5E	5.5kV	0.5E	50	1	5.59 (141)	0.81 (20)	-
5.5AMWNA1E	5.5kV	1E	50	1	5.59 (141)	0.81 (20)	-
5.5AMWNA2E	5.5kV	2E	50	1	5.59 (141)	0.81 (20)	-
5.5AMWNA3E	5.5kV	3E	50	1	5.59 (141)	0.81 (20)	-
5.5AMWNA4E	5.5kV	4E	50	1	5.59 (141)	0.81 (20)	-
5.5AMWNA5E	5.5kV	5E	50	1	5.59 (141)	0.81 (20)	-
5.5ABWNA0.5E	5.5kV	0.5E	50	1	5.59 (141)	1 (25)	-
5.5ABWNA1E	5.5kV	1E	50	1	5.59 (141)	1 (25)	-
5.5ABWNA2E	5.5kV	2E	50	1	5.59 (141)	1 (25)	-
5.5ABWNA3E	5.5kV	3E	50	1	5.59 (141)	1 (25)	-
5.5ABWNA5E	5.5kV	5E	50	1	5.59 (141)	1 (25)	-
5.5CAV15E	5.5kV	15E	50	1	7.36 (186)	1.63 (41)	6 (152)
5.5CAVH0.5E	5.5kV	0.5E	50	1	7.36 (186)	1.63 (41)	6 (152)
5.5CAVH1E	5.5kV	1E	50	1	7.36 (186)	1.63 (41)	6 (152)
5.5CAVH2E	5.5kV	2E	50	1	7.36 (186)	1.63 (41)	6 (152)
7.2AMWNA0.5E	7.2kV	0.5E	50	1	5.59 (141)	0.81 (20)	-
7.2AMWNA1.0E	7.2kV	1E	50	1	5.59 (141)	0.81 (20)	-
7.2AMWNA2.0E	7.2kV	2E	50	1	5.59 (141)	0.81 (20)	-
7.2AMWNA3.0E	7.2kV	3E	50	1	5.59 (141)	0.81 (20)	-
7.2AMWNA4.0E	7.2kV	4E	50	1	5.59 (141)	0.81 (20)	-
7.2AMWNA5.0E	7.2kV	5E	50	1	5.59 (141)	0.81 (20)	-
15.5CAV0.5E	15.5kV	0.5E	80	1	12.87 (326)	1.63 (41)	11.5 (292)
15.5CAV1E	15.5kV	1E	80	1	12.87 (326)	1.63 (41)	11.5 (292)
15.5CAV2E	15.5kV	2E	80	1	12.87 (326)	1.63 (41)	11.5 (292)
15.5CAV3E	15.5kV	3E	80	1	12.87 (326)	1.63 (41)	11.5 (292)
15.5CAV5E	15.5kV	5E	80	1	12.87 (326)	1.63 (41)	11.5 (292)
15.5CAV7E	15.5kV	7E	80	1	12.87 (326)	1.63 (41)	11.5 (292)
15.5CAVH0.5E	15.5kV	0.5E	80	1	12.87 (326)	1.63 (41)	11.5 (292)
15.5CAVH1E	15.5kV	1E	80	1	12.87 (326)	1.63 (41)	11.5 (292)
15.5CAVH2E	15.5kV	2E	80	1	12.87 (326)	1.63 (41)	11.5 (292)
38CAVH0.5E	38kV	0.5E	40	1	17.32 (439)	1.63 (41)	15 (381)
38CAVH1E	38kV	1E	40	1	17.32 (439)	1.63 (41)	15 (381)
38CAVH2E	38kV	2E	40	1	17.32 (439)	1.63 (41)	15 (381)
38CAV4E	38kV	4E	40	1	17.32 (439)	1.63 (41)	15 (381)

E-Rated Fuse Links: 5.5kV CL-14 and Bolt-In

ECL055

Specifications

Description: E-Rated medium voltage, current limiting fuses for transformer and feeder protection.



Ratings:

Rated Voltage: 5.5kV E-Rated

Rated Current: 10 - 900A

Breaking Capacity: 63kA Sym. Max

Agency Information: Meets E requirements per ANSI C37.46, meets General Purpose requirements per ANSI C37.40.

Typical Applications:

- 5kV Transformer primary protection.
- 5kV Feeder circuit protection.
- 5kV Voltage switches.
- 5kV Metal-enclosed switchgear.

Part Numbers

Part Numbers	Rated Voltage (kV)	Rated Current (E)	Breaking Capacity (Sym) kA	Number of Barrels
ECL055-10E	5.5	10	63	1
ECL055-15E	5.5	15	63	1
ECL055-20E	5.5	20	63	1
ECL055-25E	5.5	25	63	1
ECL055-30E	5.5	30	63	1
ECL055-40E	5.5	40	63	1
ECL055-50E	5.5	50	63	1
ECL055-65E	5.5	65	63	1
ECL055-80E	5.5	80	63	1
ECL055-100E	5.5	100	63	1
ECL055-125E	5.5	125	63	1
ECL055-150E	5.5	150	63	1
ECL055-200E	5.5	200	63	1
ECL055-250E	5.5	250	63	1
ECL055-300E	5.5	300	63	2
ECL055-400E	5.5	400	63	2
ECL055-450E	5.5	450	63	2
ECL055-500E	5.5	500	63	2
ECL055-600E	5.5	600	63	2
ECL055-750E	5.5	750	63	3
ECL055-900E	5.5	900	63	3

Part Number Construction (example)

Part Number	Voltage Rating	Ampere Rating
ECL	055	300E

(055 = 5.5kV)

E-Rated Fuse Links: 8.3kV CL-14

ECL083

Specifications

Description: E-rated medium voltage, current limiting fuses for transformer and feeder protection.



Ratings:

Rated Voltage: 8.3kV E-Rated

Rated Current: 65 - 350A

Breaking Capacity: 50kA

Agency Information: Meets E requirements per ANSI C37.46, meets General Purpose requirements per ANSI C37.40.

Typical Applications:

- 8.3kV Transformer primary protection.
- 8.3kV Feeder circuit protection.
- 8.3kV Voltage switches.
- 8.3kV Metal-enclosed switchgear.

Part Numbers

Part Numbers	Rated Voltage (kV)	Rated Current (E)	Breaking Capacity (Sym) kA	Number of Barrels
ECL083-65E	8.3	65	50	1
ECL083-80E	8.3	80	50	1
ECL083-100E	8.3	100	50	1
ECL083-125E	8.3	125	50	1
ECL083-150E	8.3	150	50	1
ECL083-175E	8.3	175	50	1
ECL083-200E	8.3	200	50	2
ECL083-250E	8.3	250	50	2
ECL083-300E	8.3	300	50	2
ECL083-350E	8.3	350	50	2

Part Number Construction (example)

Part Number	Voltage Rating	Ampere Rating
ECL	083	300E

(083 = 8.3kV)

E-Rated Fuse Links: 15.5kV CL-14

ECL155

Specifications

Description: E-rated medium voltage, current limiting fuses for transformer and feeder protection.



Ratings:

Rated Voltage: 15.5kV E-Rated

Rated Current: 10 - 300A

Breaking Capacity: 63kA Sym. (10-200A)

50kA Sym. (250-300A)

Agency Information: Meets E requirements per ANSI C37.46, meets General Purpose requirements per ANSI C37.40.

Typical Applications:

- 15kV transformer primary protection.
- 15kV feeder circuit protection.
- 15kV voltage switches.
- 15kV metal-enclosed switchgear.

Part Numbers

Part Numbers	Rated Voltage (kV)	Rated Current (E)	Breaking Capacity (Sym) kA	Number of Barrels
ECL155-10E	15.5	10	63	1
ECL155-15E	15.5	15	63	1
ECL155-20E	15.5	20	63	1
ECL155-25E	15.5	25	63	1
ECL155-30E	15.5	30	63	1
ECL155-40E	15.5	40	63	1
ECL155-50E	15.5	50	63	1
ECL155-65E	15.5	65	63	1
ECL155-80E	15.5	80	63	1
ECL155-100E	15.5	100	63	1
ECL155-125E	15.5	125	63	1
ECL155-150E	15.5	150	63	2
ECL155-200E	15.5	200	63	2
ECL155-250E	15.5	250	50	2
ECL155-300E	15.5	300	50	2

Part Number Construction (example)

Part Number	Voltage Rating	Ampere Rating
ECL	155	300E

(155 = 15.5kV)

R-Rated Fuse Links for Motor Circuit Protection

Specifications

Description: Indoor/enclosure R-Rated medium voltage, current-limiting fuse links for motor circuit protection.

Ratings:

Rated Voltage: 2.4 - 7.2kV
 Rated Current: 25 - 450A
 Breaking Capacity: 50kA Sym



Agency Information: UL recognized: 2540Vac — JCK, JCK-A, 5080Vac — JCL, JCL-A, UL recognized (Guide #MSSS2, File #E96676).

Typical Applications:

- Medium voltage motor controllers.

Dimensions

Figure 1

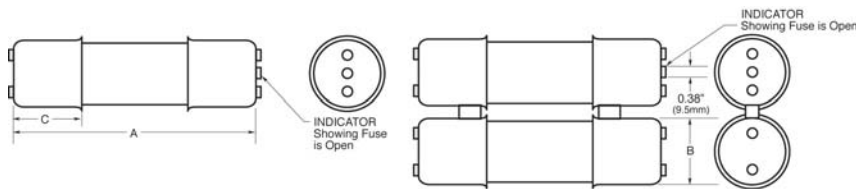

Figure 2

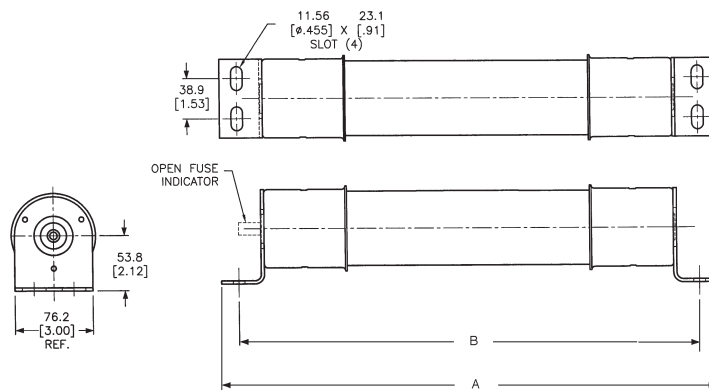
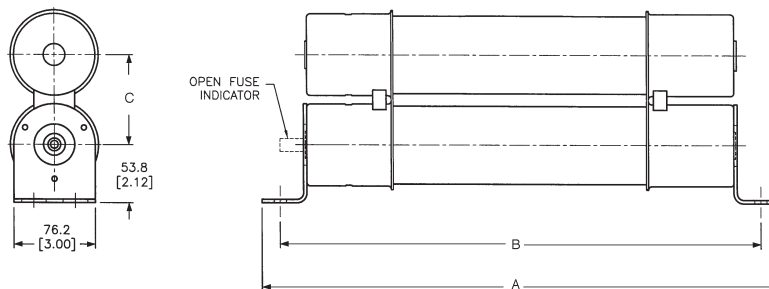

Figure 3



R-Rated Fuse Links for Motor Circuit Protection

Part Numbers

Part Numbers	Rated Current (A)	Interrupting Capacity Sym kA	Number of Barrels	Length in (mm)	Diameter in (mm)
2400V (see figure 1)					
JCK-2R	70A	50	1	11.24 (285)	3 (76)
JCK-3R	100A	50	1	11.24 (285)	3 (76)
JCK-4R	130A	50	1	11.24 (285)	3 (76)
JCK-5R	150A	50	1	11.24 (285)	3 (76)
JCK-6R	170A	50	1	11.24 (285)	3 (76)
JCK-9R	200A	50	1	11.24 (285)	3 (76)
JCK-12R	230A	50	1	11.24 (285)	3 (76)
JCK-18R	390A	50	2	11.24 (285)	3 (76)
JCK-24R	450A	50	2	11.24 (285)	3 (76)
2400V - With Westinghouse Ampguard Hookeye (see figure 1)					
JCK-A-2R	70A	50	1	11.24 (285)	3 (76)
JCK-A-3R	100A	50	1	11.24 (285)	3 (76)
JCK-A-4R	130A	50	1	11.24 (285)	3 (76)
JCK-A-5R	150A	50	1	11.24 (285)	3 (76)
JCK-A-6R	170A	50	1	11.24 (285)	3 (76)
JCK-A-9R	200A	50	1	11.24 (285)	3 (76)
JCK-A-12R	230A	50	1	11.24 (285)	3 (76)
JCK-A-18R	390A	50	2	11.24 (285)	3 (76)
JCK-A-24R	450A	50	2	11.24 (285)	3 (76)
2400V - Bolt-On (see figures 2 and 3)					
JCK-B-30	25A	50	1	14.18 (360)	3 (76)
JCK-B-2R	70A	50	1	14.18 (360)	3 (76)
JCK-B-3R	100A	50	1	14.18 (360)	3 (76)
JCK-B-4R	130A	50	1	14.18 (360)	3 (76)
JCK-B-5R	150A	50	1	14.18 (360)	3 (76)
JCK-B-6R	170A	50	1	14.18 (360)	3 (76)
JCK-B-9R	200A	50	1	14.18 (360)	3 (76)
JCK-B-12R	230A	50	1	14.18 (360)	3 (76)
JCK-B-18R	390A	50	2	14.18 (360)	3 (76)
JCK-B-24R	450A	50	2	14.18 (360)	3 (76)
2400V - Hermetically Sealed, for Use with Ampguard Motor Starters (see figure 1)					
JCH-30	25A	50	1	10.81 (275)	3 (76)
JCH-2R	70A	50	1	10.81 (275)	3 (76)
JCH-3R	100A	50	1	10.81 (275)	3 (76)
JCH-4R	130A	50	1	10.81 (275)	3 (76)
JCH-5R	150A	50	1	10.81 (275)	3 (76)
JCH-6R	170A	50	1	10.81 (275)	3 (76)
JCH-9R	200A	50	1	10.81 (275)	3 (76)
JCH-12R	230A	50	1	10.81 (275)	3 (76)
JCH-18R	390A	50	2	10.81 (275)	3 (76)
JCH-24R	450A	50	2	10.81 (275)	3 (76)
4800V (see figure 1)					
JCL-2R	70	50	1	15.76 (400)	3 (76)
JCL-3R	100	50	1	15.76 (400)	3 (76)
JCL-4R	130	50	1	15.76 (400)	3 (76)
JCL-5R	150	50	1	15.76 (400)	3 (76)
JCL-6R	170	50	1	15.76 (400)	3 (76)
JCL-9R	200	50	1	15.76 (400)	3 (76)
JCL-12R	230	50	1	15.76 (400)	3 (76)
JCL-18R	390	50	2	15.76 (400)	3 (76)
JCL-24R	450	50	2	15.76 (400)	3 (76)

R-Rated Fuse Links for Motor Circuit Protection

Part Numbers

Part Numbers	Rated Current (A)	Interrupting Capacity Sym kA	Number of Barrels	Length in (mm)	Diameter in (mm)
4800V - With Westinghouse Ampguard Hookeye (see figure 1)					
JCL-A-2R	70	50	1	15.76 (400.3)	3 (76.2)
JCL-A-3R	100	50	1	15.76 (400.3)	3 (76.2)
JCL-A-4R	130	50	1	15.76 (400.3)	3 (76.2)
JCL-A-5R	150	50	1	15.76 (400.3)	3 (76.2)
JCL-A-6R	170	50	1	15.76 (400.3)	3 (76.2)
JCL-A-9R	200	50	1	15.76 (400.3)	3 (76.2)
JCL-A-12R	230	50	1	15.76 (400.3)	3 (76.2)
JCL-A-18R	390	50	2	15.76 (400.3)	3 (76.2)
JCL-A-24R	450	50	2	15.76 (400.3)	3 (76.2)
4800V - Bolt-On (see figures 2 and 3)					
JCL-B-30	30	50	1	19.25 (488.9)	3 (76.2)
JCL-B-2R	70	50	1	19.25 (488.9)	3 (76.2)
JCL-B-3R	100	50	1	19.25 (488.9)	3 (76.2)
JCL-B-4R	130	50	1	19.25 (488.9)	3 (76.2)
JCL-B-5R	150	50	1	19.25 (488.9)	3 (76.2)
JCL-B-6R	170	50	1	19.25 (488.9)	3 (76.2)
JCL-B-9R	200	50	1	19.25 (488.9)	3 (76.2)
JCL-B-12R	230	50	1	19.25 (488.9)	3 (76.2)
JCL-B-18R	390	50	2	19.25 (488.9)	3 (76.2)
JCL-B-24R	450	50	2	19.25 (488.9)	3 (76.2)
4800V - Hermetically Sealed, for use with Ampguard Motor Starters (see figure 1)					
JCG-30	30	50	1	15.91 (404.1)	3 (76.2)
JCG-2R	70	50	1	15.91 (404.1)	3 (76.2)
JCG-3R	100	50	1	15.91 (404.1)	3 (76.2)
JCG-4R	130	50	1	15.91 (404.1)	3 (76.2)
JCG-5R	150	50	1	15.91 (404.1)	3 (76.2)
JCG-6R	170	50	1	15.91 (404.1)	3 (76.2)
JCG-9R	200	50	1	15.91 (404.1)	3 (76.2)
JCG-12R	230	50	1	15.91 (404.1)	3 (76.2)
JCG-A-18R	390	50	2	15.91 (404.1)	3 (76.2)
JCG-A-24R	450	50	2	15.91 (404.1)	3 (76.2)
7200V - With Ampguard Hookeye (see figure 1)					
JCR-A-2R	70	50	1	15.85 (402.6)	3 (76.2)
JCR-A-3R	100	50	1	15.85 (402.6)	3 (76.2)
JCR-A-4R	130	50	1	15.85 (402.6)	3 (76.2)
JCR-A-5R	150	50	1	15.85 (402.6)	3 (76.2)
JCR-A-6R	170	50	1	15.85 (402.6)	3 (76.2)
JCR-A-9R	200	50	1	15.85 (402.6)	3 (76.2)
JCR-A-12R	230	50	1	15.85 (402.6)	3 (76.2)
JCR-A-18R	390	50	2	15.85 (402.6)	3 (76.2)
JCR-A-24R	450	50	2	15.85 (402.6)	3 (76.2)
7200V - Bolt-on (see figures 2 and 3)					
JCR-B-2R	70	50	1	19.25 (488.9)	3.31 (84.1)
JCR-B-3R	100	50	1	19.25 (488.9)	3.31 (84.1)
JCR-B-4R	130	50	1	19.25 (488.9)	3.31 (84.1)
JCR-B-5R	150	50	1	19.25 (488.9)	3.31 (84.1)
JCR-B-6R	170	50	1	19.25 (488.9)	3.31 (84.1)
JCR-B-9R	200	50	1	19.25 (488.9)	3.31 (84.1)
JCR-B-12R	230	50	1	19.25 (488.9)	3.31 (84.1)
JCR-B-18R	390	50	2	19.25 (488.9)	3.31 (84.1)
JCR-B-24R	450	50	2	19.25 (488.9)	3.31 (84.1)

Fuse Clips

- VT Fuse Clips for 25.4mm diameter.
- DIN standard Clips for 'F' and 'T' range fuse links.
- BS Mounting Clips suitable for 50.8mm and 76.2mm Oil, Air, and Motor Fuse Links up to 200A.



Cooper Bussmann Fuse Clips

To complement the range of tag fixings offered by Cooper Bussmann, a range of fuse clips are available. These are suitable for use with British Standard, DIN dimensioned and VT ferrule style fuse links. The BS and DIN clips are rated up to 200 Amps. They are designed to be fitted onto insulated studs or directly onto a busbar.

General Guide to the Selection of Fuse Clips

Fuse Clips	Clip Reference
DIN fuse links to 43625	270303 or A3354745
Voltage transformer and auxiliary type fuse links	A3354705
British Standard fuse links	
50.8mm (2") diameter	A3354710
63.5mm (2") diameter	A3354720
76.2mm (2") diameter	A3354730

Clips for 25.4mm VT Fuse Links

Material: Nickel silver alloy
Order as part number: A3354705

Dimensions (mm)

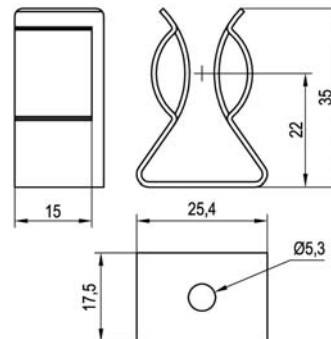

Fuse Clips

Clips for DIN Fuse Links

Material: Nickel-plated copper
 Order as part number: 270303
 Suitable for use with Cooper Bussmann DIN fuse links. Also suitable for use with other Cooper Bussmann fuse links having type 'J' end tags, to DIN 43625, with maximum current rating of 200 Amps

Dimensions (mm)

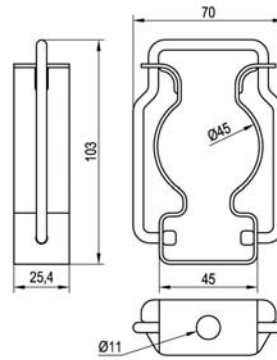

Clips for British Standard and DIN Style Fuse Links

Material: Nickel-plated copper
 Order as part number:
 A3354745 for 45mm diameter
 A3354710 for 50.8mm diameter
 A3354720 for 63.5mm diameter
 A3354730 for 76.2mm diameter

Dimensions (mm)

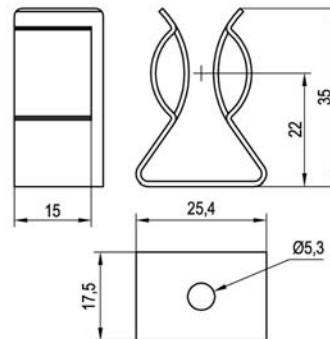

Fuse Diameter (D)	H	W	C
45	86	112	48
50.8	86	112	48
63.5	95	124	54
76.2	100	140	58

Expulsion Fuse Links for Use in High Voltage Distribution Cut-Outs

- Wide range of options available from 15kV to 72kV in ANSI T & K characteristics.
- Extra rapid option also available.



Cooper Bussmann Expulsion Fuse Links

Cooper Bussmann expulsion fuse links have been widely used throughout the world for over 40 years. They have in that time built up a formidable reputation and consistency of performance.

Cooper Bussmann expulsion fuse links are designed to be interchangeable with other types of manufacturers cut-out units and are available in several patterns.

Application

Expulsion fuse links current ratings should be selected on the basis of maximum expected transient no damage currents rather than on full load current. In addition, the selection of higher current ratings will reduce the possibility of supply interruption due to transient surges such as those due to lightning strikes (for information on our Surge Protection Device SPD, please contact buletechnical@cooperindustries.com).

Links should be handled with a reasonable degree of care when installing. Excessively rough handling may damage the element.

It is normal, under certain fault conditions, for arc extinguishing material and/or metal particles to be expelled from the fuse assembly. It is therefore recommended that reasonable precautions be taken to prevent the installation being approached by unauthorised persons.

How to order - Parts Referencing System

Rated Voltage (kV)	1st Letter Type of Current Characteristics	2nd Letter Type of Termination	Rated Current (A)
15 25 46 72	<p>T = complies with ANSI C 37-42 requirements for slow acting T characteristics</p> <p>K = complies with ANSI C 37-42 requirements for fast acting K characteristics</p> <p>XA = this type of expulsion fuse link has an extra rapid characteristic. It is suitable for applications where a high degree of system protection is required at the expense of discrimination</p> <p>S = Solid links rated at 100A are also available in both button head and universal versions for fitting into expulsion fuse carriers where required. These can be ordered in a similar way using the abbreviation S, e.g. 15SB, etc</p>	<p>B = a fixed NEMA button head link</p> <p>U = a universal link, with double tail and slip off NEMA button head</p> <p>D = double tailed link without NEMA button head</p> <p>BR = as pattern B but the button head is attached via a 1/4 UNF thread to allow use of an extension rod.</p> <p>See outline drawings opposite page for reference</p>	1, 2, 3, 4, 5, 6, 7.5, 8, 10, 12, 15, 20, 25, 30, 40, 50, 60, 65, 75, 80, 100

Thus a typical ordering reference for a 15kV NEMA type K, button head 30A fuse link would be **15KB30** expulsion fuse link.

The fuse link assembly for a given range is standard to all rated voltages. The exception is that the tail length is varied to suit the dimensions of expulsion carrier of different ratings.

Expulsion Fuse Links

Specifications

Description: Expulsion fuse links available in a wide range of options from 15kV to 72kV in ANSI T&K characteristics.

Ratings:

Rated Voltage: 15 to 72kV

Amps: 1 to 100A

Breaking Capacity: depends on voltage but is approximately 8kA

Agency Information:

Type T: complies with ANSI C37-42

Type K: complies with ANSI C37-42

Time-Current Curves and Cut-Off Curves: see list page 119 and data on CD at the back of the catalogue.

Dimensions (mm):

1-50A

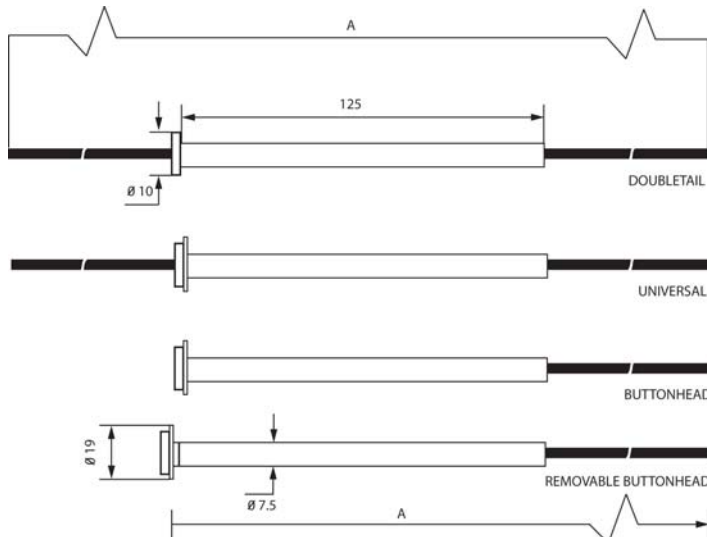

60-100A

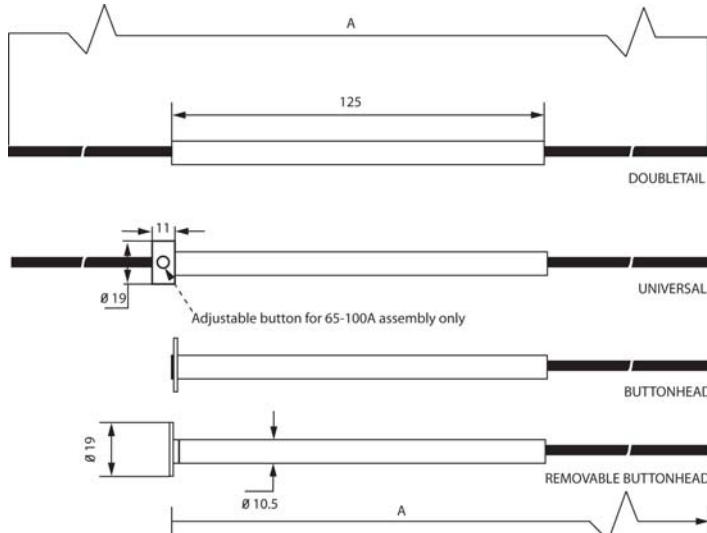

Packaging:

Up to and including 50A: 25 in a carton

From 60A to 100A: 10 in a carton

To avoid incorrect replacement the fuse links have colour coded labels:

Pink label: Type XA

Yellow label: Type K

Green label: Type T

Typical Applications:

- Primary side transformer protection
- Feeder protection
- Capacitor bank protection

Type kV	A
15kV	533 (21")
25kV	660 (26")
46kV	787 (31")
72kV	1016 (40")

Notes: Type BR is similar to button head shown, except that the button head is attached via a 1/4 UNF thread.

Tails can be cut to any length.

ASL - Automatic Sectionalising Links

- Low cost retrofit option for spur line isolation in place of existing expulsion fuse links.
- Available for up to 33kV lines.
- Standard pick-up current ratings of 20, 25, 40, 50, 63, 100 Amps.
- Other ratings up to 320 Amps available.
- Available in single or 3-phase ganged arrangements.
- Enhanced lightning immunity performance.



Cooper Bussmann Automatic Sectionalising Link ASL (Smart Links)

Cooper Bussmann low cost retrofit Automatic Sectionalising Link (ASL), represents a significant breakthrough in the field of high voltage overhead line distribution system protection. It is a completely self-contained device designed for use with multi-shot circuit breakers or auto-reclosers. The ASL was originally developed by Cooper Bussmann from invention by the Electrical Council Research Centre, now EA technology in the UK.

Cooper Bussmann ASL ensures effective overhead spur line isolation in the event of a genuine local fault, while at the same time remaining unresponsive to transient (temporary) no-damage surge currents, caused by electrical storms etc, see figure 1.

How the Sectionaliser Works

The sectionaliser houses a logic circuit in its main conductive carrying tube. This ensures the electronic circuitry is free from electrical interference, as the tube acts as an effective Faraday cage and is powered by a small current transformer mounted on the outside of the carrier tube.

Statistics show that 90% of expulsion fuse operations on spur lines are in response to transient no-damage faults and that the cost for each expulsion fuse link replacement can be of the same order as the capital cost of a complete fuse cut-out. The alternative approach favoured by some Utilities of replacing expulsion fuse links by solid links has the major disadvantage that any permanent fault on a spur line results in an outage of the whole system.

Cooper Bussmann ASL provides an economic solution to the problem, by ensuring effective spur line isolation in the event of a genuine local fault, while at the same time remaining unresponsive to transient no-damage surge currents.

Figure 1

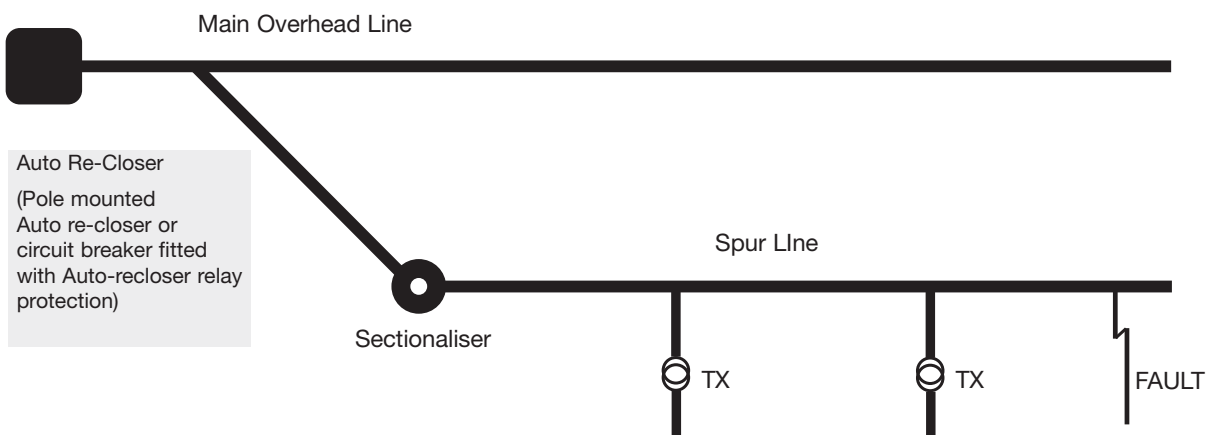

ASL - Automatic Sectionalising Links

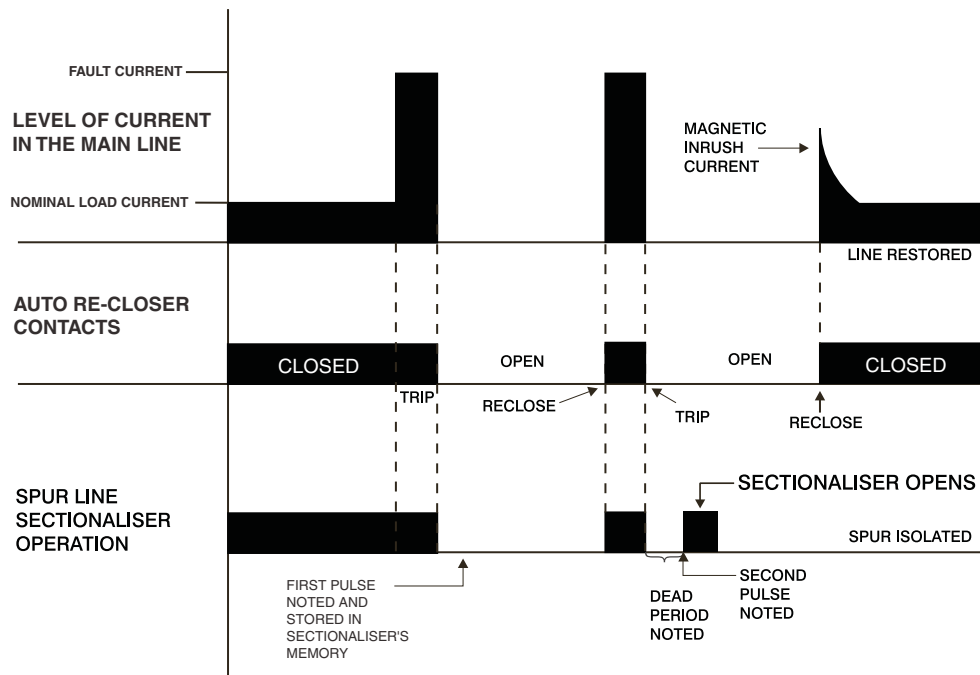

Sectionaliser Isolating a Spur-Line Fault

Operation is accomplished by discharging a capacitor into a small chemical actuator (or 'striker') which unlatches the carrier tube and causes it to swing down. The ASL is reset by fitting a replacement actuator and re-inserting the carrier into its mount.

The logic circuit is designed to inhibit response to transformer magnetising inrush current surges and induced current waves resulting from electrical storms. Therefore, in practice any spur line fault condition which persists for a time of several seconds will operate the ASL, so isolating the spur as illustrated above. Any transient or 'no damage' current will be ignored.

Operational Sequence

The logic circuit on the printed circuit board within the ASL is powered by a small current transformer mounted on the outside of the conductive carrier tube. Under normal load conditions the printed circuit board remains inert. However, should the line current increase above a certain pre-set value (the pick-up current) the logic circuit activates. The upstream auto re-closer then opens, temporarily removing the fault from the line. The logic circuit, powered by an internal capacitor, stores the incident for around 25 seconds (the 'reclaim' time). When the upstream device re-closes, some three to ten seconds later, if the fault current is no longer in evidence, the ASL will ignore the incident and eventually reverts to an inert state again. However if the fault current (i.e. a current above the pick-up value) is still present, the logic circuit will decide that this represents a permanent fault on the spur line and will prepare to de-latch. The logic circuit is however, inhibited from operating the latch mechanism until the upstream recloser has tripped for the second time and the line current has fallen to a value of less than 300mA (the 'hold-off' current) for a period of at least 0.1 second. The ASL thus operates during the dead time of the upstream protective device and does so quietly, without sparks or ionised gas emission and without contact erosion.

ASL - Automatic Sectionalising Links

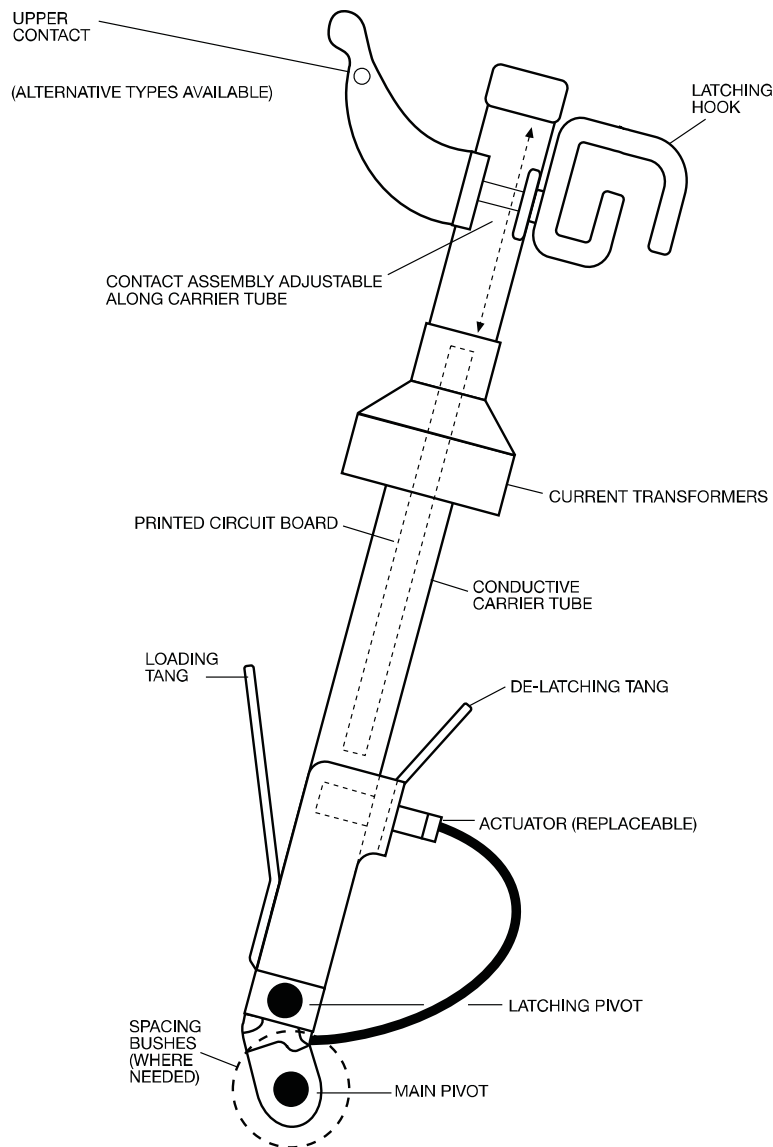

Mounting Arrangements

The contact assemblies of the ASL are adjustable to allow for use with a variety of types of expulsion fuse mount. Alternative upper contact assemblies are available. These can be either fitted to the ASL during manufacture or may be provided loose as conversion kits. ASLs can also be provided complete with suitable 'fuse mounts' where required.

Applications

The ASL must be used in conjunction with either an upstream circuit breaker having multi-shot reclose facility or an auto-recloser. In either case the dead time of the device must be appreciably less than the 25 second ASL reclaim time.

The most useful pick-up current setting is likely to be 100A. This will allow protection of spur line loads totalling up to 1000kVA 3-phase (11kV).

Where the total load is smaller and greater sensitivity to low level faults is required, one of the alternative lower settings can be supplied. It should be noted that the recommended pick-up current setting is approximately twice the value of the maximum load current of the connected downstream transformers.

ASL - Automatic Sectionalising Links

Additional information

- Response time: At inception <50ms
- Weight: 1.6kg
- Maximum recommended mounting height: 10 metres
- Hold off current: >300mA
- The three-phase version is available to suit Moris Line Equipment mounts only, ref. BR1T

Mounting References

Cooper Bussmann Reference	Suitable for Mount Type	Actuator Part Number
BR1	S & E Line Equipment, pre. 1967	4772968BS
BR2	Brush Power (1967 - 1987)	4772968BS
BR3	Hawker Switchgear	4772968BS
BR5	J & P (GEC)	4772964BS
BR1M	Morris Line Equipment	4772968BS
BR1T	Morris Line Triple Pole Unit	4772968BS
C	Universal USA, NEMA	4772968BS
	Replacement pack of 100 grease sachets	4772717BS

Ordering Codes

For example: 15ASL100BR1-2

Symbol					Meaning
Rating Voltage	Product Type	Pick-up Current in Amps	Mounting Arrangements	Number of Shots	
15					Sectionaliser to be used in 15kV cut-outs
	ASL				Automatic Sectionalising Link (ASL)
		100			The pick-up current will be set at 100 Amps
			BR1		Details the contact arrangement for a given fuse mount. (See mounting references in the table above)
				2	Details the number of current pulses, or shots, the unit will accept before operating either 1, 2 or 3 multi.
15	ASL	100	BR1	2	Total Part Number

Boric Acid Fuse Links

- Expulsion style fuse link complete with a single-pole porcelain fuse mount.
- Available from 17kV to 38kV, 3 to 200A.
- Can be used indoors and outdoors.
- ANSI C.37 and Australian standard AS1033.



Introduction

Cooper Bussmann BBU medium voltage Boric Acid fuse link and complementary fuse mount or cut-out package is an expulsion fuse link style fuse, complete with a single-pole porcelain fuse mount offering medium voltage protection for indoor and outdoor applications.

The fuse mount is available at either 17 or 27kV and is designed to withstand the most hazardous environmental conditions. The contact system is made from a copper alloy ensuring a long service life in the field.

The fuse mount already has the outdoor fittings, so simply adding a Cooper Bussmann BBU fuse link will deliver a complete outdoor transformer protection solution.

Cooper Bussmann range of BBU fuse links can be used indoors as well as outdoors. A muffler attachment can be ordered to limit noise and contamination to indoor equipment during operation.

BBU fuse links are designed to be interchangeable with other leading manufacturers and are available from 17kV through to 38kV, from 3 to 200 amps, with K, E and SE time-current characteristics.

Boric Acid fuse link employs calibrated silver elements combined with boric acid crystals for its interruption media. The mechanical utilisation of the spring and rod mechanism creates an interruption technique that offers mild exhaustion during fault interruption.

Boric Acid fuse links are ideally suited to provide distribution transformer protection within electrical distribution networks.

Features of BBU Fuses

A complete distribution transformer package from a single source. Cooper Bussmann offers a single source for all of your protection needs, both fuse links and fuse mount are fully interchangeable with other manufacturers product lines.

Sealed fuse links - All BBU fuse links are sealed from moisture ingress, preventing deterioration of performance in the fields and improving overall network reliability while reducing costs.

Fully tested - Cooper Bussmann BBU fuse links are tested to both ANSI C.37 and Australian standard AS1033.1, which due to Australia's unique landscape and harsh climate, is widely regarded as the most onerous type test of expulsion fuse link style protection in the world today.

Single piece end fittings - Cooper Bussmann fuse link package comes with single piece end fittings, reducing set-up time in the field and lowering inventory, thereby improving network productivity.

Single wrench installation - The fuse links are designed to be installed with a single type of tool, again reducing maintenance, replacement and installation costs.

Other features to improve safety and overall reliability induce the use of a Nichrome strain element, to reduce susceptibility to spurious operation in the field caused by vibration and corona, a glass epoxy tube, preventing warping during long time exposure and permanent date marking facilitating a more robust Operation and Maintenance regime.

Boric Acid Fuse Links

BBU Fuse Link Mount Construction

Bird proof design insulator provides insulation characteristics higher than ANSI distribution cut-out standards and equal in most cases to ANSI switch and bus standards

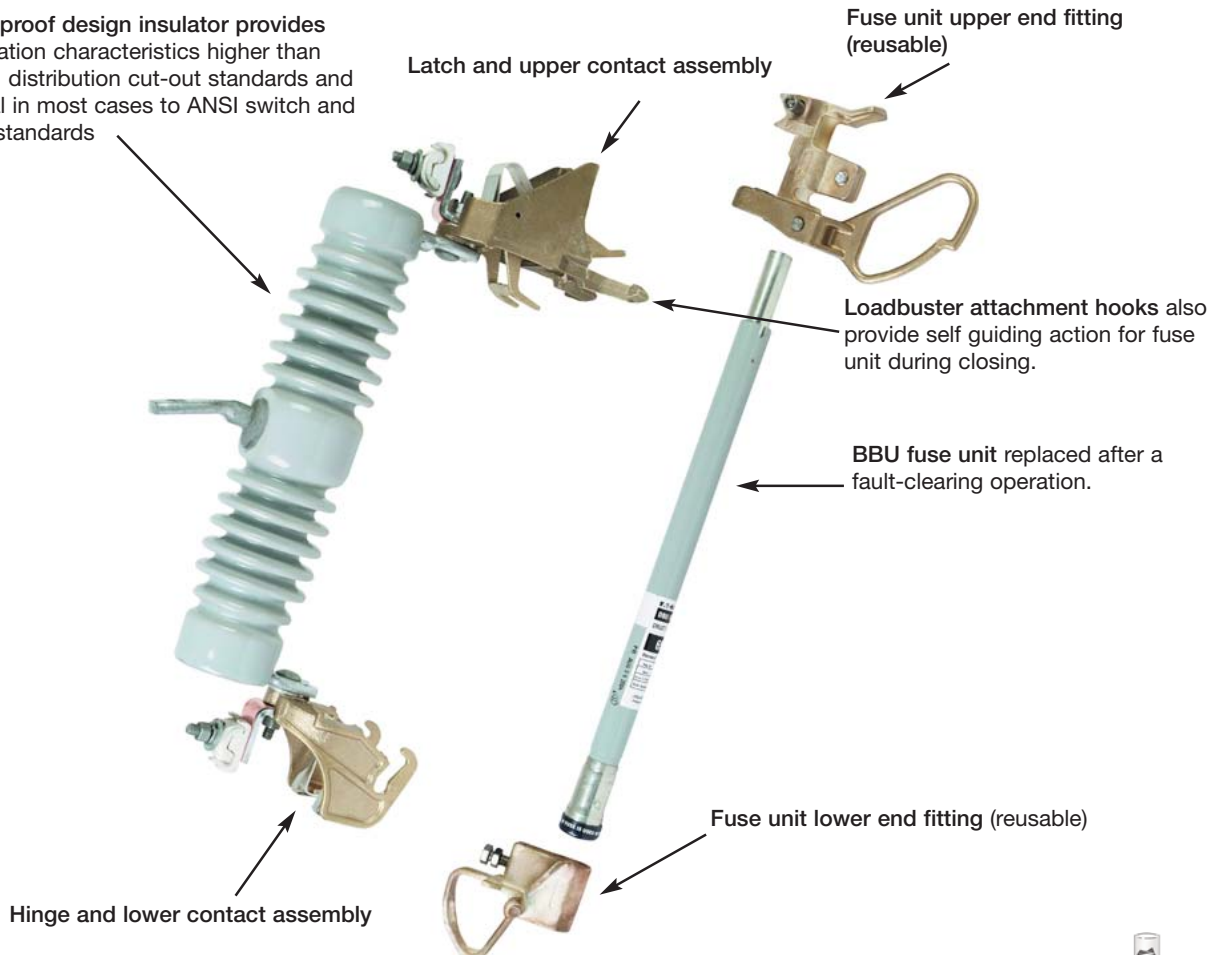

BBU Fuse construction

Principle parts of the replaceable BBU fuse unit are shown in the cross section view. Main operating parts are the silver element, arcing rod, boric acid cylinder and spring. A glass epoxy tube encloses the assembly.

The use of a pure silver element and Nichrome wire stain element makes the BBU less susceptible to outages caused by vibration, corona corrosion, and aging of the fuse elements. It is not damaged by transient faults or overloads which approach the minimum melt point.

The components are housed in a fiberglass reinforced resin tube with plated copper contacts. Positive connection is maintained between the arcing rod and contact with a sliding tulip contact.



BBU End Fittings



Fuse unit lower end fitting
Part number (including Muffler): BBU-EFID



Fuse unit upper end fitting
Part number (including Muffler): BBU-EFID



Muffler:
Part number-BBU-MFLR

Boric Acid Fuse Links

Operation

BBU expulsion fuse links utilise the proven performance of boric acid to create the de-ionizing action needed to interrupt the current. Fault interruption is achieved by the action of an arcing rod and a charged spring, elongating the arc through a boric acid chamber upon release by the fuse element.

At high temperatures, boric acid decomposes, producing a blast of water vapor and inert boric anhydride. Electrical interruption is caused by the steam extinguishing the arc, as the arc is being elongated through the cylinder.

Higher particle turbulence of the boric acid causes the rate of de-ionization in the cylinder to exceed the ionization of the electrical arc. Both high and low current faults are interrupted in the same manner with no foreign material other than the boric acid required. This enables the fuse to interrupt short-circuit within one half cycle and prevents the arc from restriking after a current zero.

After interruption, the gases are expelled from the bottom of the fuse.

The arcing rod is prevented from falling back into its original position by a friction stop at the top of the fuse unit.

When the fuse operates, the upward motion of the spring forces the top of the arcing rod to penetrate the upperseal, striking the latch mechanism.

On indoor applications, this action caused the blown fuse indicator to actuate.

When replacing the blown fuse link, the end fittings should be removed from the operated fuse unit, and if undamaged, clamped onto the new fuse unit.

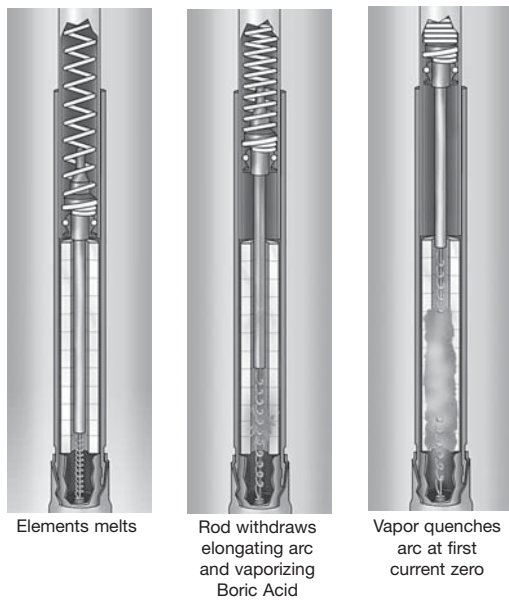

Application

The BBU Boric acid fuse provides effective protection for circuits and equipment which operate on voltage system up to 34.5kV. They can be used on industrial distribution systems and all fuses are designed for use on the following:

- Power transformers
- Feeder circuits
- Distribution transformers
- Metal-enclosed switchgear
- Pad mount switches

BBU fuse units can be used in indoor applications, and can be used to directly replace competitive equivalent units.

Boric Acid Fuses

Outdoor BBU Mount

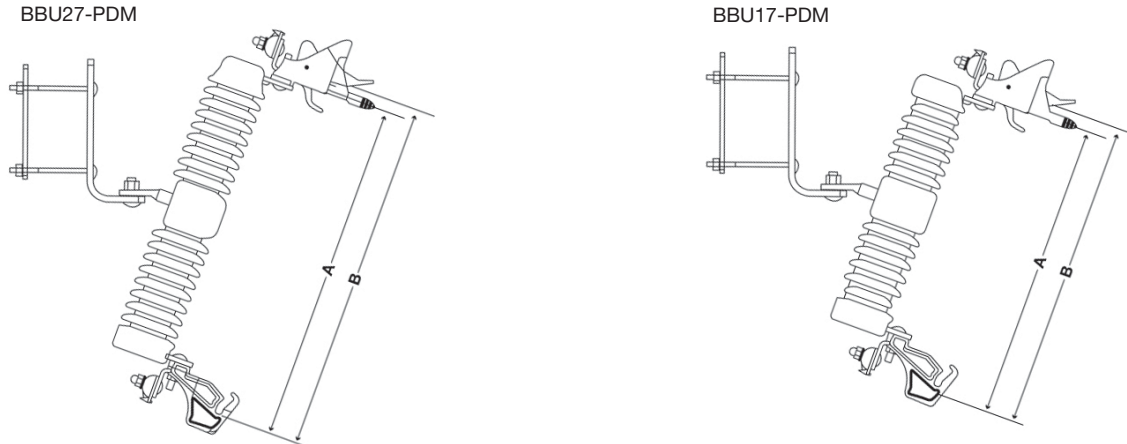

Part Number	1Min High Voltage Withstand Test kV	Total Insulator Length Inches (mm)	A Inches (mm)	B Inches (mm)	Approximate Weight (kg)
BBU27-PDM	42	18.3 (465)	20.4 (516.9)	21 (534)	20
BBU17-PDM	35	14.8 (375)	16.8 (426.9)	17.5 (444)	17.5

Outdoor BBU Fuse Fitting

Outdoor end fittings are made of a cast-copper plated alloy. A large hook eye on the upper fitting allows for easy installation into pole-top mountings with a hook stick. The pivotal design of this hook eye provides for proper engagement of the upper live part. The positive locking action of the latch mechanism prevents detachment from the mounting due to shock or vibration. In the event of a fault, the arcing rod will penetrate through the upper end of the fuse unit, and cause the latch to release. Once released, the fuse will rotate down into the drop-out position to indicate a blow fuse condition. The lower end fitting has two cylindrical posts that insert into the lower live part of the mounting. These posts allow the fuse to rotate into the proper engaged position, and suspend the fuse during a blown, drop-out condition.

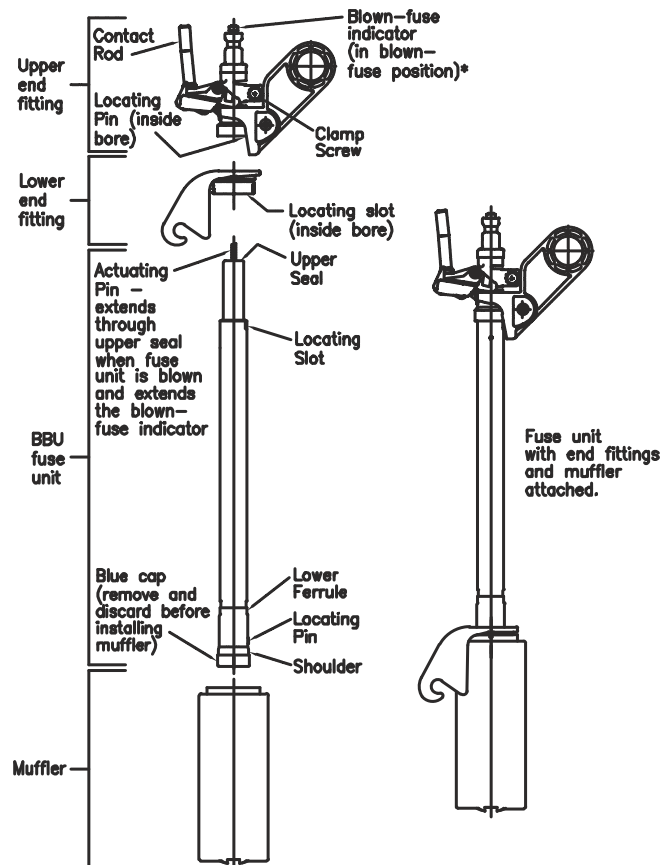

Boric Acid Fuse Links

Fuse Dimensions

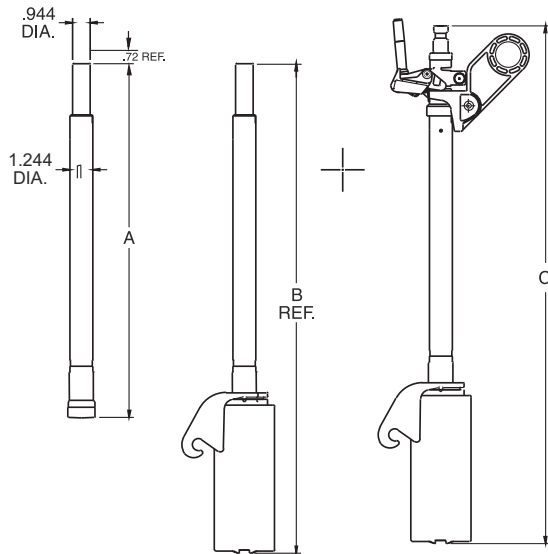

kV max	Fuse Unit Fitting inches (mm)		
	A	B	C
17	19.08 (484)	27.19 (690)	28.82 (732)
27	22.58 (573)	30.69 (779)	32.32 (821)
38	28.76 (730)	36.87 (936)	38.50 (978)

Application Notes

Low currents, usually referred to as overload currents, must be considered as BBU fuses have a rather low thermal capacity. They cannot carry overloads of the same magnitude/duration as motors and transformers of equal continuous currents. For this reason, the BBU fuse must be sized with the load current in mind so the fuse does not open on otherwise acceptable overloads and inrush conditions. Coordination should be considered to help determine what type of fuse is applied. The BBU fuse interrupts at a natural current zero in the current wave and allows minimum of a half-cycle of fault current to flow before the fault is cleared. The time-current characteristics associated with a BBU fuse has a rather gradual slope making it easier to coordinate with downstream equipment. In addition, the BBU is ideal for higher voltage (up to 38kV) and high current applications (up to 200A). It is important to examine the minimum melting and total clearing time-current characteristics of this fuse.

Standards

Cooper Bussmann does not compromise when performance, quality and safety are involved. Exacting standards have been established relative to the design, testing and application of expulsion type power fuses. Compliance with these standards ensures the best selection and performance. The BBU Power Fuses are designed and tested for compliance to global standards such as ANSI and Australian Standard AS1033.1 1990. ANSI (American National Standards Institute) is a non-profit privately funded membership organization that coordinates the development of the US voluntary national standards.

Testing

Cooper Bussmann BBU Power fuse links and fuse mounts were tested in compliance to the standards listed below. This testing was carried out in independent test laboratories in Canada and in Australia by recognised independent power testings laboratories. Thermal and interrupting testing was conducted at 17, 27kV. The entire series of tests was conducted in a specific sequence as stipulated by governing standards without any maintenance being performed. All tests results are verified by laboratory tabulations and oscillogram plots.

- ANSI C37.40 - Service conditions and definitions
- ANSI C37.41 - Power fuse design and testing
- ANSI C37.42 - Distribution fuse ratings and specification
- ANSI C37.46 - Power fuse ratings and specifications
- ANSI C37.48 - Power fuse application, operation and maintenance
- AS1033.1 1990 - Australian standard high voltage fuses expulsion type

Boric Acid Fuse Links

Specifications

Description: Expulsion fuse link style fuse, complete with a single pole porcelain fuse mount offering medium voltage protection for indoor and outdoor applications.

Ratings:

Rated Voltage: 17 - 38kV (for the fuse link)
17 and 27kV (for the fuse mount)

Amps: 3 - 200A (for the fuse link)

IR: 10, 12 or 14kA

Time-Current Curves: see curves on CD at the back of the catalogue.

Part Numbers

Part Number	Rated Current (A)	Voltage kV	Breaking Capacity kA	Fuse Type
BBU17-3K	3	17	14	K
BBU17-6K	6			
BBU17-8K	8			
BBU17-10K	10			
BBU17-12K	12			
BBU17-15K	15			
BBU17-20K	20			
BBU17-25K	25			
BBU17-30K	30			
BBU17-40K	40			
BBU17-50K	50			
BBU17-65K	65			
BBU17-80K	80			
BBU17-100K	100			
BBU17-140K	140			
BBU17-200K	200			
BBU17-5E	5	17	14	E
BBU17-7E	7			
BBU17-10E	10			
BBU17-13E	13			
BBU17-15E	15			
BBU17-20E	20			
BBU17-25E	25			
BBU17-30E	30			
BBU17-40E	40			
BBU17-50E	50			
BBU17-65E	65			
BBU17-80E	80			
BBU17-100E	100			
BBU17-125E	125			
BBU17-150E	150			
BBU17-175E	175			
BBU17-200E	200			

Agency Information: refer to the 'Standards' paragraph page 106.

Typical Applications:

- Power transformers
- Feeder circuits
- Distribution transformers
- Metal enclosed switchgear
- Pad mount switches

Part Number	Rated Current (A)	Voltage kV	Breaking Capacity kA	Fuse Type
BBU17-15SE	15	17	14	SE
BBU17-20SE	20			
BBU17-25SE	25			
BBU17-30SE	30			
BBU17-40SE	40			
BBU17-50SE	50			
BBU17-65SE	65			
BBU17-80SE	80			
BBU17-100SE	100			
BBU17-125SE	125			
BBU17-150SE	150			
BBU17-175SE	175			
BBU17-200SE	200			

The BBU fuse is offered in three constructions to meet specific melt curves for an application. The construction is designated in the part number suffix: E (Standard), K (Fast) and SE (Slow). Contact Cooper Bussmann for application details: buletechnical@cooperindustries.com

Boric Acid Fuse Links

Part Numbers

Part Number	Rated Current (A)	Voltage kV	Breaking Capacity kA	Fuse Type
BBU27-3K	3	27	12.5	K
BBU27-6K	6			
BBU27-8K	8			
BBU27-10K	10			
BBU27-12K	12			
BBU27-15K	15			
BBU27-20K	20			
BBU27-25K	25			
BBU27-30K	30			
BBU27-40K	40			
BBU27-50K	50			
BBU27-65K	65			
BBU27-80K	80			
BBU27-100K	100			
BBU27-140K	140			
BBU27-200K	200			
BBU27-5E	5	27	12.5	E
BBU27-7E	7			
BBU27-10E	10			
BBU27-13E	13			
BBU27-15E	15			
BBU27-20E	20			
BBU27-25E	25			
BBU27-30E	30			
BBU27-40E	40			
BBU27-50E	50			
BBU27-65E	65			
BBU27-80E	80			
BBU27-100E	100			
BBU27-125E	125			
BBU27-150E	150			
BBU27-175E	175			
BBU27-200E	200			
BBU27-15SE	15	27	12.5	SE
BBU27-20SE	20			
BBU27-25SE	25			
BBU27-30SE	30			
BBU27-40SE	40			
BBU27-50SE	50			
BBU27-65SE	65			
BBU27-80SE	80			
BBU27-100SE	100			
BBU27-125SE	125			
BBU27-150SE	150			
BBU27-175SE	175			
BBU27-200SE	200			

Part Number	Rated Current (A)	Voltage kV	Breaking Capacity kA	Fuse Type
BBU38-3K	3	38	10	K
BBU38-6K	6			
BBU38-8K	8			
BBU38-10K	10			
BBU38-12K	12			
BBU38-15K	15			
BBU38-20K	20			
BBU38-30K	30			
BBU38-40K	40			
BBU38-50K	50			
BBU38-65K	65			
BBU38-80K	80			
BBU38-100K	100			
BBU38-140K	140			
BBU38-200K	200			
BBU38-5E	5			
BBU38-7E	7			
BBU38-10E	10			
BBU38-13E	13			
BBU38-15E	15			
BBU38-20E	20			
BBU38-25E	25			
BBU38-30E	30			
BBU38-40E	40			
BBU38-50E	50			
BBU38-65E	65			
BBU38-80E	80			
BBU38-100E	100			
BBU38-125E	125			
BBU38-150E	150			
BBU38-175E	175			
BBU38-200E	200			
BBU38-15SE	15	38	10	SE
BBU38-20SE	20			
BBU38-25SE	25			
BBU38-30SE	30			
BBU38-40SE	40			
BBU38-50SE	50			
BBU38-65SE	65			
BBU38-80SE	80			
BBU38-100SE	100			
BBU38-125SE	125			
BBU38-150SE	150			
BBU38-175SE	175			
BBU38-200SE	200			

The BBU fuse is offered in three constructions to meet specific melt curves for an application. The construction is designated in the part number suffix: E (Standard), K (Fast) and SE (Slow). Contact Cooper Bussmann for application details: buletechnical@cooperindustries.com

Cross Reference

DIN Fuse Links

Cooper Bussmann	EFEN	SIBA	MESA	ETI (80N Striker)	ETI (50N Striker)	Merlin Gerin	Elimsan	Inael	ABB
3.6kV									
3.6ADOSJ6.3	67110.0060	3000213	CF-7.2/6.3	4226005	4225005	51006 500 M0	N/A	3.6 IB-D2 6.3	1YMB531001M0001
3.6ADOSJ10	67110.0100	3000213	CF-7.2/10	4226006	4225006	51007.501.M0	N/A	3.6 IB-D2 10	1YMB531001M0002
3.6ADOSJ16	67110.0160	3000213	CF-7.2/16	4226007	4225007	51008 502.M0	N/A	3.6 IB-D2 16	1YMB531001M0003
3.6ADOSJ20	67110.0200	3000213	CF-7.2/20	4226008	4225008	51009 503 M0	N/A	3.6 IB-D2 20	N/A
3.6ADOSJ25	67110.0250	3000213	CF-7.2/25	4226009	4225009	51010 504 M0	N/A	3.6 IB-D2 25	1YMB531001M000
3.6ADOSJ31.5	67110.0320	3000213	CF-7.2/31.5	4226010	4225010	51011 505 M0	N/A	3.6 IB-D2 31.5	N/A
3.6ADOSJ40	67110.0400	3000213	CF-7.2/40	4226011	4225011	51012 506 M0	N/A	3.6 IB-D2 40	1YMB53100M0005
3.6WDOSJ50	67110.0500	3000213	CF-7.2/50	4226012	4225012	51013 507 M0	N/A	3.6 IB-D2 50	1YMB531001M0006
3.6WDOSJ63	67110.0630	3001013	CF-7.2/63	4226013	4225013	51014 508 M0	N/A	3.6 IB-D2 63	1YMB531001M0007
3.6WDOSJ80	67110.0800	3001013	CF-7.2/80	4226014	4225014	51015 509 M0	N/A	3.6 IB-D2 80	1YMB531001M0008
3.6WDOSJ100	67110.1000	3001013	CF-7.2/100	4226015	4225015	51016 510 M0	N/A	3.6 IB-D2 100	1YMB531001M0009
3.6WDOSJ125	67110.1250	3001013	N/A	4226016	4225016	N/A	N/A	N/A	N/A
3.6WFOSJ160	67110.1600	3001813	N/A	4226017	4225017	N/A	N/A	N/A	N/A
3.6WFOSJ200	67210.2000	3001814	N/A	N/A	N/A	N/A	N/A	N/A	N/A
7.2kV									
7.2TDLSJ6.3	N/A	3009813	N/A	N/A	N/A	N/A	N/A	N/A	1YMB531034M0001
7.2TDLSJ10	N/A	3009813	N/A	N/A	N/A	N/A	N/A	N/A	1YMB531034M0002
7.2TDLSJ16	N/A	3009813	N/A	N/A	N/A	N/A	N/A	N/A	1YMB531034M0003
7.2TDLSJ20	N/A	3009813	N/A	N/A	N/A	N/A	N/A	N/A	N/A
7.2TDLSJ25	N/A	3009813	N/A	N/A	N/A	N/A	N/A	N/A	1YMB531034M0004
7.2TDLSJ31.5	N/A	3009813	N/A	N/A	N/A	N/A	N/A	N/A	N/A
7.2TDLSJ40	N/A	3009813	N/A	N/A	N/A	N/A	N/A	N/A	1YMB531034M0005
7.2TDLSJ50	N/A	3009813	N/A	N/A	N/A	N/A	N/A	N/A	1YMB531034M0006
7.2TDLSJ63	N/A	3009913	N/A	N/A	N/A	N/A	N/A	N/A	1YMB531034M0007
7.2TFLSJ80	N/A	3009913	N/A	N/A	N/A	N/A	N/A	N/A	1YMB531034M0008
7.2TFLSJ100	N/A	3009913	N/A	N/A	N/A	N/A	N/A	N/A	1YMB531034M0009
7.2TFLSJ125	N/A	3009913	CF-7.2/125	N/A	N/A	757352 BN	N/A	N/A	1YMB531034M0010
7.2TFLSJ160	N/A	3010013	CF-7.2/160	N/A	N/A	757352 BP	N/A	N/A	1YMB531034M0011
12kV									
12TDLEJ6.3	67120.0060	3000413	CF-12/6.3	4236005	4235005	51006 511 M0	ES 6509 006	12 IB-D1 6.3	1YMB531042M0001
12TDLEJ10	67120.0100	3000413	CF-12/10	4236006	4235006	51006 512 M0	ES 6509 010	12 IB-D1 10	1YMB531042M0002
12TDLEJ16	67120.0160	3000413	CF-12/16	4236007	4235007	51006 513 M0	ES 6509 016	12 IB-D1 16	1YMB531042M0003
12TDLEJ20	67120.0200	3000413	CF-12/20	4236008	4235008	51006 514 M0	ES 6509 020	12 IB-D1 20	1YMB531042M0004
12TDLEJ25	67120.0250	3000413	CF-12/25	4236009	4235009	51006 515 M0	ES 6509 025	12 IB-D1/D2 25	1YMB531002M0004
12TDLEJ31.5	67120.0320	3000413	CF-12/31.5	4236010	4235010	51006 516 M0	ES 6509 030	12 IB-D1/D2 31.5	1YMB531002M0014
12TDLEJ40	67120.0400	3000413	CF-12/40	4236011	4235011	51006 517 M0	ES 6509 040	12 IB-D1/D2 40	1YMB531002M0005
12TDLEJ50	67120.0500	3000413	CF-12/50	4236012	4235012	51006 518 M0	ES 6509 050	12 IB-D2 50	1YMB531002M0006
12TDLEJ63	67120.0630	3001213	CF-12/63	4236013	4235013	51006 519 M0	ES 6509 063	12 IB-D2 63	1YMB531002M0007
12THLEJ80	67120.0800	3001213	CF-12/80	4236014	4235014	51006 520 M0	ES 6509 080	12 IB-D3 80	1YMB531002M0021
12THLEJ100	67120.1000	3001213	CF-12/100	4236015	4235015	51006 521 M0	ES 6509 100	12 IB-D3 100	1YMB531002M0022
12TKLEJ125	67120.1250	3001213	N/A	4236016	4235016	N/A	N/A	N/A	1YMB531043M0010
12TXLEJ160	67220.1600	3002013	N/A	4236017	4235017	N/A	N/A	N/A	N/A
12TXLEJ200	67220.2000	3002014	N/A	N/A	N/A	N/A	N/A	N/A	N/A
12THMEJ100	67004-1000	3010213	CF-12/100	4236515	4235515	757364CN	N/A	N/A	1YMB531035M0022
12TFMSJ160	67004-1600	3010313	CF-12/160	4236517	4235517	757354C	N/A	N/A	1YMB531035M0011

Cross Reference

DIN Fuse Links

Cooper Bussmann	EFEN	SIBA	MESA	ETI (80N Striker)	ETI (50N Striker)	Merlin Gerin	Elimsan	Inael	ABB
17.5kV									
17.5TDLSJ6.3	N/A	3025513	N/A	N/A	N/A	N/A	N/A	17.5 IB-D1 6.3	1YMB531003M0001
17.5TDLSJ10	N/A	3025513	CFR-17.5/10	N/A	N/A	51006 522 M0	N/A	17.5 IB-D1 10	1YMB531003M0002
17.5TDLSJ16	N/A	3025513	CFR-17.5/16	N/A	N/A	51006 523 M0	N/A	17.5 IB-D1 16	1YMB531003M0003
17.5TDLSJ20	N/A	3022113	N/A	N/A	N/A	N/A	N/A	17.5 IB-D1 20	1YMB531003M0013
17.5TDLSJ25	N/A	3022113	CFR-17.5/25	N/A	N/A	51006 524 M0	N/A	17.5 IB-D1/D2 25	1YMB531003M0004
17.5TDLSJ31.5	N/A	3022113	CFR-17.5/31.5	N/A	N/A	51006 525 M0	N/A	17.5 IB-D1/D2 31.5	1YMB531003M0014
17.5TDLSJ40	N/A	3022113	CFR-17.5/40	N/A	N/A	51006 525 M0	N/A	17.5 IB-D1/D2 40	1YMB531003M0021
17.5TFLSJ50	N/A	3022113	N/A	N/A	N/A	N/A	N/A	17.5 IB-D2 50	1YMB531003M0022
17.5TDMEJ6.3	N/A	3023113	N/A	N/A	N/A	N/A	N/A	17.5 IB-D1 6.3	1YMB531037M0001
17.5TDMEJ10	N/A	3023113	N/A	N/A	N/A	N/A	N/A	17.5 IB-D1 10	1YMB531037M0002
17.5TDMEJ16	N/A	3023113	N/A	N/A	N/A	N/A	N/A	17.5 IB-D1 16	1YMB531037M0003
17.5TDMEJ20	N/A	3023113	N/A	N/A	N/A	N/A	N/A	17.5 IB-D1 20	1YMB531037M0013
17.5TDMEJ25	N/A	3023113	N/A	N/A	N/A	N/A	N/A	17.5 IB-D1 25	1YMB531037M0004
17.5TDMEJ31.5	N/A	3023113	N/A	N/A	N/A	N/A	N/A	17.5 IB-D1 31.5	1YMB531037M0014
17.5TDMEJ40	N/A	3023113	N/A	N/A	N/A	N/A	N/A	17.5 IB-D1 40	1YMB531037M0021
17.5TDMEJ50	N/A	3023213	N/A	N/A	N/A	N/A	N/A	N/A	1YMB531037M0006
17.5TDMEJ63	N/A	3023213	N/A	N/A	N/A	N/A	N/A	17.5 IB-D2 63	1YMB531037M0007
17.5THMEJ80	N/A	3023213	N/A	N/A	N/A	N/A	N/A	N/A	1YMB531037M0008
17.5THMEJ100	N/A	3023313	N/A	N/A	N/A	N/A	N/A	17.5 IB-D2 100	1YMB531003M0009
17.5TKMEJ125	N/A	3023414	N/A	N/A	N/A	N/A	N/A	N/A	1YMB531003M0010
24kV									
24TDMEJ6.3	67140.0060	3000613	CF-24/6.3	4256005	4255005	51006 538 M0	ES 6513-006	24 IB-D1 6.3	1YMB531044M0001
24TDMEJ10	67140.0100	3000613	CF-24/10	4256006	4255006	51006 539 M0	ES 6513-010	24 IB-D1 10	1YMB531044M0002
24TDMEJ16	67140.0160	3000613	CF-24/16	4256007	4255007	51006 540 M0	ES 6513-016	24 IB-D1 16	1YMB531044M0003
24TDMEJ20	67140.0200	3000613	CF-24/20	4256008	4255008	51006 541 M0	ES 6513-020	24 IB-D1 20	1YMB531044M0004
24TDMEJ25	67140.0250	3000613	CF-24/25	4256009	4255009	51006 542 M0	ES 6513-025	24 IB D1/D2 25	1YMB531004M0004
24TDMEJ31.5	67140.0320	3000613	CF-24/31.5	4256010	4255010	51006 543 M0	ES 6513-030	24 IB D1/D2 31.5	1YMB531004M0012
24TDMEJ40	67140.0400	3000613	CF-24/40	4256011	4255011	51006 544 M0	ES 6513-040	24 IB D1/D2 40	1YMB531004M0005
24TDMEJ50	67140.0500	3001413	CF-24/50	4253012	4255012	51006 545 M0	ES 6513-050	24 IB-D2 50	1YMB531004M0021
24THMEJ63	67140.0630	3001413	CF-24/63	4253013	4255013	51006 546 M0	ES 6513-063	24 IB-D2 63	1YMB531004M0022
24TFMEJ80	67140.0800	3001413	CF-24/80	4253014	4255014	51006 547 M0	ES 6513-080	24 IB-D3 80	1YMB531022M0001
24TFMEJ100	67240.1000	3002213	CF-24/100	4253015	4255015	51006 548 M0	ES 6513-100	24 IB-D3 100	1YMB531022M0002
24TXMEJ125	67240.1250	3002213	N/A	4253016	4255016	N/A	N/A	N/A	1YMB531022M0003
24TXMEJ160	67240.1600	N/A	N/A	N/A	N/A	N/A	N/A	N/A	N/A
36kV									
36TDQJSJ3.15	N/A	N/A	N/A	N/A	N/A	N/A	N/A	N/A	N/A
36TDQJSJ6.3	67150.0060	3000813	CF-36/6.3	4266005	4265005	51006 549 M0	ES 6515-006	24 IB-D1 6.3	1YMB531006M0001
36TDQJSJ10	67150.0100	3000813	CF-36/10	4266006	4265006	51006 550 M0	ES 6515-010	24 IB-D1 10	1YMB531006M0002
36TDQJSJ16	67150.0160	3000813	CF-36/16	4266007	4265007	51006 551 M0	ES 6515-016	24 IB-D1 16	1YMB531006M0003
36TDQJSJ20	67150.0200	3000813	CF-36/20	4266008	4265008	51006 552 M0	ES 6515-020	24 IB-D1 20	N/A
36TDQJSJ25	67150.0250	3000813	CF-36/25	4266009	4265009	51006 553 M0	ES 6515-025	24 IB-D1 25	1YMB531006M0004
36TFQJSJ31.5	67150.0320	3000813	CF-36/31.5	4266010	4265010	51006 554 M0	ES 6515-030	24 IB-D1 31.5	N/A
36TFQJSJ40	67150.0400	3000813	CF-36/40	4266011	4265011	51006 555 M0	ES 6515-040	24 IB-D1 40	1YMB531006M0005
36TFQJSJ50	67150.0500	3000813	CF-36/50	4266012	4265012	51006 556 M0	ES 6515-050	24 IB-D1 50	N/A
36TXQEJ63	67150.0630	3000813	CF-36/63	4266013	4265013	51006 557 M0	ES 6515-063	24 IB-D1 63	N/A

Cross Reference

Motor Fuse Links

Cooper Bussmann	SIBA	GE	ABB
3.6kV			
3.6WDFHO50	3026956-50		
3.6WDFHO63	3026956-63		
3.6WDFHO80	3026956-80		
3.6WDFHO100	3026956-100	K81PEX100	
3.6WDFHO125	3026956-125	K81PEX125	
3.6WFFHO160	3026956-160	K81PEX160	
3.6WFFHO200	3026956-200	K81PEX200	
3.6WFFHO250	3026956-250	K81PEX250	
3.6WKFHO315	3026956-315	K81PEX315	
3.6WKFHO355		K81PEX350 (1)	
3.6WKFHO400		K81PEX450 (2)	
3.6WFGHO100	3025513-100		1YMB531031M0001
3.6WFGHO150			1YMB531031M0002
3.6WFGHO200			1YMB531031M0003
3.6WFGHO250			1YMB531031M0004
3.6WKGHO315			1YMB531031M0005
3.6WDLSJ50	3020153-50		
3.6WDLSJ63	3020153-63		
3.6WDLSJ80	3020153-80		
3.6WDLSJ100	3020153-100		1YMB531028M0001
3.6WDLSJ125	3020253-125		
3.6WFLSJ160	3020253-160		1YMB531028M0002
3.6WFLSJ200	3020253-200		1YMB531028M0003
3.6WKLSJ250	3020054-250		1YMB531028M0004
3.6WKLSJ315	3020054-315		1YMB531028M0005
7.2kV			
7.2WFNHO50	3027156-50	K81SDX50	
7.2WFNHO63	3027156-63	K81SDX63	1YMB531032M0001
7.2WFNHO80	3027156-80	K81SDX80	
7.2WFNHO100	3027156-100	K81SDX100	1YMB531032M0002
7.2WFNHO125	3027156-125	K81SDX125	
7.2WFNHO160	3027156-160	K81SDX160	1YMB531032M0003
7.2WFNHO200	3027156-200	K81SDX200	1YMB531032M0004
7.2WKNHO224	3027156-224	K81SDX225	
7.2WKNHO250	3027156-250	K81SDX250	1YMB531032M0005
7.2WKNHO315	3027156-315	K81SDX315	1YMB531032M0006
7.2WFMSJ50	3010853-50		
7.2WFMSJ63	3010853-63		1YMB531029M0001
7.2WFMSJ80	3010853-80		
7.2WFMSJ100	3010853-100		1YMB531029M0002
7.2WFMSJ125	3010953-125		
7.2WFMSJ160	3010953-160		1YMB531029M0003
7.2WKMSJ200	3011054-200		1YMB531029M0004
7.2WKMSJ224	3011054-224		
7.2WKMSJ250	3011054-250		1YMB531029M0005
7.2WKMSJ315	3011054-315		1YMB531029M0006

- (1) GE's fuse link is rated 355A, Cooper Bussmann's 350A
(2) GE's fuse link is rated at 450A, Cooper Bussmann's at 400A

Voltage and Auxiliary Fuse Links

Cooper Bussmann	SIBA	GE
3.6kV		
3.6ABWNA3.15		AIR3.3/3
7.2kV		
7.2ABWNA3.15	3038311-3	VTF6.6/3
7.2ABCNA3.15	3037711-3	
7.2OBCNA3.15		VTF6.6/3
12kV		
12ABCNA3.15	3037811-3	VTF11/3
12ABCN223.15		5XVTF11/3
12OBCNA3.15		VTF11/3
12OBCN223.15		5XVTF11/3
15.5kV		
15.5ABFNA3.15		VTF15/3
15.5OBFNA3.15		VTF15/3
15.5ABFNA223.15		6XVTF15/3
15.5OBFN223.15		6XVTF15/3
17.5kV		
17.5ABGNA3.15	3037911-3	
24kV		
24ABGNA3.15	3038011-3	

Please note the Cooper Bussmann fuse links above are rated at 3.15A. GE and Siba's are rated at 3A.

Cross Reference

Oil Fuse Links

Cooper Bussmann	Siba	GE	Notes
3.6kV			
3.6OEFMA6.3	3013236-6.3*		Cooper Bussmann fuse link can only be used at a maximum of 3.6kV
3.6OEFMA10	3013236-10*		Cooper Bussmann fuse link can only be used at a maximum of 3.6kV
3.6OEFMA16	3013236-16*		Cooper Bussmann fuse link can only be used at a maximum of 3.6kV
3.6OEFMA20	3013236-20*		Cooper Bussmann fuse link can only be used at a maximum of 3.6kV
3.6OEFMA25	3013236-25*		Cooper Bussmann fuse link can only be used at a maximum of 3.6kV
3.6OEFMA31.5	3013236-31.5*		Cooper Bussmann fuse link can only be used at a maximum of 3.6kV
3.6OEFMA40	3013236-40*		Cooper Bussmann fuse link can only be used at a maximum of 3.6kV
3.6OEFMA50	3013236-50*		Cooper Bussmann fuse link can only be used at a maximum of 3.6kV
3.6OEFMA63	3013236-63*		Cooper Bussmann fuse link can only be used at a maximum of 3.6kV
3.6OEFMA80	3013236-80*		Cooper Bussmann fuse link can only be used at a maximum of 3.6kV
3.6OEFMA100	3013236-100*	KSBXO100	Cooper Bussmann fuse link can only be used at a maximum of 3.6kV
7-2kV			
7.2OEFMA80	3013236-80		
7.2OEFMA100	3013236-100	KSBXO100	
7.2OEFMA112	3013236-112		
7.2OHGMA100		KSMXO100	
7.2OHGMA125	3023436-125	KSMXO120	GE fuse link is rated at 120A, Cooper Bussmann at 125A
7.2OHGMA140		KSMXO140	
7.2OHGMA160	3023436-160		
12kV			
12OEFMA6.3	3014436-6.3	KEBXO5	GE fuse link is rated at 5A, Cooper Bussmann at 6.3A
12OEFMA10	3014436-10	KEBXO10	
12OEFMA16	3014436-16	KEBXO16	
12OEFMA20	3014436-20	KEBXO20	
12OEFMA25	3014436-25	KEBXO25	
12OEFMA31.5	3014436-31.5	KEBXO36	GE fuse link is rated at 36A, Cooper Bussmann at 31.5A
12OEFMA40	3014436-40	KEBXO40	
12OEFMA50	3014436-50	KEBXO50	
12OEFMA63	3014436-63	KEBXO63	
12OHFMA80	3014436-80	KEBXO80	
15.5kV			
15.5OEFMA25		KFBXO25	
15.5OEFMA31.5		KFBXO36	GE fuse link is rated at 36A, Cooper Bussmann at 31.5A
15.5OEFMA40		KFBXO40	
15.5OEFMA50		KFBXO50	
15.5OEFMA63		KFBXO63	
15.5OHGMA80		KFMXO85	GE fuse link is rated at 85A, Cooper Bussmann at 80A
15.5OLGMA100		KFMXO100	
17.5kV			
17.5OHGMA20		KFMXO20	
17.5OHGMA25		KFMXO25	
17.5OHGMA31.5		KFMXO32	
17.5OHGMA40		KFMXO40	
17.5OHGMA50		KFMXO50	
17.5OHGMA63		KFMXO63	
17.5OHGMA80		KFMXO80	
24kV			
24OEGMA6.3	3023736-6.3**		
24OEGMA10	3023736-10**	KTMXO10***	Cooper Bussmann fuse link can only be used at a maximum 24kV
24OEGMA16	3023736-16**		
24OEGMA20	3023736-20**	KTMXO20***	Cooper Bussmann fuse link can only be used at a maximum 24kV
24OEGMA25	3023736-25**	KTMXO25***	Cooper Bussmann fuse link can only be used at a maximum 24kV
24OEGMA31.5	3023736-31.5**	KTMXO32***	Cooper Bussmann fuse link can only be used at a maximum 24kV
24OEGMA40	3023736-40**	KTMXO40***	Cooper Bussmann fuse link can only be used at a maximum 24kV
24OEGMA50	3023736-50**	KTMXO50***	

* SIBA fuse links are rated at 7.2kV
 ** SIBA fuse links are rated at 12kV
 *** GE fuse links are rated at 25.8kV

Cross Reference

British Standard Air Fuse Links

Cooper Bussmann	SIBA
3.6kV	
3.6ADFHA6.3*	3024136-6.3
3.6ADFHA10*	3024136-10
3.6ADFHA16*	3024136-16
3.6ADFHA20*	3024136-20
3.6ADFHA25*	3024136-25
3.6ADFHA31.5*	3024136-31.5
3.6ADFHA40*	3024136-40
7.2kV	
7.2ADFHA6.3	3024136-6.3
7.2ADFHA10	3024136-10
7.2ADFHA16	3024136-16
7.2ADFHA20	3024136-20
7.2ADFHA25	3024136-25
7.2ADFHA31.5	3024136-31.5
7.2ADFHA40	3024136-40
7.2ADFHA50	3024136-50
7.2ADFHA63	3024136-63
7.2AFFHA80	3013536-80
7.2AFFHA100	3013536-100
7.2BDGHA6.3	3024236-6.3
7.2BDGHA10	3024236-10
7.2BDGHA16	3024236-16
7.2BDGHA20	3024236-20
7.2BDGHA25	3024236-25
7.2BDGHA31.5	3024236-31.5
7.2BDGHA40	3024236-40
7.2BDGHA50	3024236-50
7.2BDGHA63	3024236-63
7.2BDGHA80	3024236-80
7.2BFGHA100	3013736-100
7.2BFGHA125	3013736-125
7.2BFGHA140	3013736-140
7.2BFHA160	3013736-16
7.2BDGHC6.3	3024636-6.3
7.2BDGHC10	3024636-10
7.2BDGHC16	3024636-16
7.2BDGHC20	3024636-20
7.2BDGHC25	3024636-25
7.2BDGHC31.5	3024636-31.5
7.2BDGHC40	3024636-40
7.2BDGHC50	3024636-50
7.2BDGHC63	3024636-63
7.2BDGHC80	3024636-80
7.2BFGHC90	3024936-90
7.2BFGHC100	3024936-100
7.2BFGHC125	3024936-125
7.2BFGHC140	3024936-140
7.2BFGHC160	3024936-160

Cooper Bussmann	SIBA	GE
12kV		
12ADFHA6.3	3014136-6.3	
12ADFHA10	3014136-10	
12ADFHA16	3014136-16	
12ADFHA20	3014136-20	
12ADFHA25	3014136-25	
12ADFHA31.5	3014136-31.5	
12AFFHA40	3013536-40	
12AFFHA50	3013536-50	
12AFFHA63	3013536-63	
12ADFN6B31.5		K6EB32
12AFFN6B40		K6EB40
12AFFN6B50		K6EB50
12AFFN6B63		K6EB63
12BDGHA6.3	3024336-6.3	
12BDGHA10	3024336-10	
12BDGHA16	3024336-16	
12BDGHA20	3024336-20	
12BDGHA25	3024336-25	
12BDGHA31.5	3024336-31.5	
12BDGHA40	3024336-40	
12BDGHA50	3024336-50	
12BFGHA50	3014736-50	
12BFGHA63	3014736-63	
12BFGHA80	3014736-80	
12BFGHA100	3014736-100	
12AKGHA125	3014736-125	
12BDGHC6.3	3024736-6.3	
12BDGHC10	3024736-10	
12BDGHC16	3024736-16	
12BDGHC20	3024736-20	
12BDGHC25	3024736-25	
12BDGHC31.5	3024736-31.5	
12BDGHC40	3024736-40	
12BDGHC50	3024736-50	
12BFGHC63	3025036-63	
12BFGHC80	3025036-80	
12BFGHC90	3025036-90	
12BFGHC100	3025036-100	
12AKGHC125	3025036-125	
15.5kV		
15.5BDGHC6.3	3025836-6.3	
15.5BDGHC10	3024836-10	
15.5BDGHC16	3024836-16	
15.5BDGHC20	3024836-20	
15.5BDGHC25	3024836-25	
15.5BDGHC31.5	3024836-31.5	
15.5BDGHC40	3024836-40	
15.5BFGHC50	3024836-50	
15.5BFGHC63	3024836-63	
15.5BFGHC80	3024836-80	

Cooper Bussmann	SIBA
24kV	
24ADIHA6.3	3024436-6.3
24ADIHA10	3024436-10
24ADIHA16	3024436-16
24ADIHA20	3024436-20
24ADIHA25	3024436-25
24ADIHA31.5	3024436-31.5
24FIHA40	3016136-40
24AFIHA50	3016136-40
24AFIHA63	3016136-63
24AFIHA80	3016136-80

* These specific Cooper Bussmann fuse links can only be used at a maximum of 3.6kV

Cross Reference

US Style E-Rated Fuse Links

Cooper Bussmann	Mersen (Ferraz Shawmut)	Eaton	GE	Littelfuse
5.5kV E-Rated fuse links for transformers and feeder protection				
MV055F1DAX10E	A055F1D0R0-10E	5HLE-10E		10E-1C-5.5
MV055F1DAX15E	A055F1D0R0-15E	5HLE-15E		15E-1C-5.5
MV055F1DAX20E	A055F1D0R0-20E	5HLE-20E		20E-1C-5.5
MV055F1DAX25E	A055F1D0R0-25E	5HLE-25E		25E-1C-5.5
MV055F1DAX80E	A055F1D0R0-80E	5HLE-80E	9F62DCB080	80E-1C-5.5
MV055F1DAX125E	A055F1D0R0-125E	5HLE-125E	9F62DCB125	125E-1C-5.5
MV055F1DAX175E	A055F1D0R0-175E	5HLE-175E	9F62DCB175	175E-1C-5.5
MV055F1DAX200E	A055F1D0R0-200E	5HLE-200E	9F62DCB200	200E-1C-5.5
MV055F2DAX300E	A055F2D0R0-300E	5HLE-300E	9F62FCB300	300E-1C-5.5
MV055F2DAX350E	A055F2D0R0-350E	5HLE-350E	9F62FCB350	350E-2C-5.5
MV055F2DAX400E	A055F2D0R0-400E	5HLE-400E	9F62FCB400	400E-2C-5.5
MV055F2DAX450E	A055F2D0R0-450E	5HLE-450E	9F62FCB450	450E-2C-5.5
5.5FFNHA30E	A055F1D0R0-30E	5HLE-30E	9F60FJD030	30E-1C-5.5
5.5FFNHA40E	A055F1D0R0-40E	5HLE-40E	9F60FJD040	40E-1C-5.5
5.5FFNHA50E	A055F1D0R0-50E	5HLE-50E	9F60FJD050	50E-1C-5.5
5.5FFNHA65E	A055F1D0R0-65E	5HLE-65E	9F60FJD065	65E-1C-5.5
8.3kV E-Rated fuse links for transformers and feeder protection				
8.25FFNHA20E	A825X20E-1	8HLE-20E	9F60FJE020	20E-1C-8.25
8.25FFNHA25E	A825X25E-1	8HLE-25E	9F60FJE025	25E-1C-8.25
8.25FFNHA30E	A825X30E-1	8HLE-30E	9F60FJE030	30E-1C-8.25
8.25FFNHA40E	A825X40E-1	8HLE-40E	9F60FJE040	40E-1C-8.25
8.25FFNHA50E	A825X50E-1	8HLE-50E	9F60FJE050	50E-1C-8.25
8.25FFNHA65E	A825X65E-1	8HLE-65E	9F60FJE065	65E-1C-8.25
15.5kV E-Rated fuse links for transformers and feeder protection				
MV155F1DBX10E	A155F1D0R0-10E	15HLE-10E		10E-1C-15.5
MV155F1DBX80E	A155F2D0R0-80E	15HLE-80E	9F60HMH080	80E-1C-15.5
MV155F1DBX100E	A155F2D0R0-100E	15HLE-100E	9F60HMH100	100E-1C-15.5
MV155F2DBX175E	A155F2D0R0-175E	15HLE-175E		175E-2C-15.5
MV155F2DBX200E	A155F2D0R0-200E	15HLE-200E		200E-2C-15.5
15.5FFVHA15E	A155F1D0R0-15E	15HLE-15E	9F60FMH015	15E-1C-15.5
15.5FFVHA20E	A155F1D0R0-20E	15HLE-20E	9F60FMH020	20E-1C-15.5
15.5FFVHA25E	A155F1D0R0-25E	15HLE-25E	9F60FMH025	25E-1C-15.5
15.5FFVHA30E	A155F1D0R0-30E	15HLE-30E	9F60FMH030	30E-1C-15.5
15.5FFVHA40E	A155F1D0R0-40E	15HLE-40E	9F60FMH040	40E-1C-15.5
15.5FFVHA50E	A155F1D0R0-50E	15HLE-50E	9F60FMH050	50E-1C-15.5
15.5FFVHA65E	A155F2D0R0-65E	15HLE-65E	9F60FMH065	65E-1C-15.5
15.5FFVHK150E	A155F2D0R0-150E	15HLE-150E		150E-2C-15.5
E-Rated fuse links: CL-14 and bolt-in 5.5kV				
ECL055-10E	A055C1D0R0-10E	5HCL-10E		10E-1CL-5.5
ECL055-15E	A055C1D0R0-15E	5HCL-15E		15E-1CL-5.5
ECL055-20E	A055C1D0R0-20E	5HCL-20E		20E-1CL-5.5
ECL055-25E	A055C1D0R0-25E	5HCL-25E		25E-1CL-5.5
ECL055-30E	A055C1D0R0-30E	5HCL-30E		30E-1CL-5.5
ECL055-40E	A055C1D0R0-40E	5HCL-40E		40E-1CL-5.5
ECL055-50E	A055C1D0R0-50E	5HCL-50E		50E-1CL-5.5
ECL055-65E	A055C1D0R0-65E	5HCL-65E		65E-1CL-5.5
ECL055-80E	A055C1D0R0-80E	5HCL-80E		80E-1CL-5.5
ECL055-100E	A055C1D0R0-100E	5HCL-100E		100E-1CL-5.5
ECL055-125E	A055C1D0R0-125E	5HCL-125E		125E-1CL-5.5
ECL055-150E	A055C1D0R0-150E	5HCL-150E		150E-1CL-5.5
ECL055-200E	A055C1D0R0-200E	5HCL-200E		
ECL055-250E	A055C1D0R0-250E	5HCL-250E		
ECL055-300E	A055C1D0R0-300E	5HCL-300E		300E-2CL-5.5
ECL055-400E	A055C1D0R0-400E	5HCL-400E		350E-2CL-5.5
ECL055-450E	A055C2D0R0-450E	5HCL-450E		400E-2CL-5.5
ECL055-500E	A055C2D0R0-500E	5HCL-500E		
ECL055-600E	A055C2D0R0-600E	5HCL-600E		
EBI055-750E	A055B3D0R0-750E	5HCL-750E		
EB1055-900E	A055B3D0R0-900E	5HCL-900E		

Cross Reference

US Style E-Rated Fuse Links

Cooper Bussmann	Mersen (Ferraz Shawmut)	Eaton	GE	Littelfuse
E-Rated fuse links: CL-14 and bolt-in - 15.5kV				
ECL155-10E	A155C1D0R0-10E	15HCL-10E		10E-1CL-15.5
ECL155-15E	A155C1D0R0-15E	15HCL-15E		15E-1CL-15.5
ECL155-20E	A155C1D0R0-20E	15HCL-20E		20E-1CL-15.5
ECL155-25E	A155C1D0R0-25E	15HCL-25E		25E-1CL-15.5
ECL155-30E	A155C1D0R0-30E	15HCL-30E		30E-1CL-15.5
ECL155-40E	A155C1D0R0-40E	15HCL-40E		40E-1CL-15.5
ECL155-50E	A155C1D0R0-50E	15HCL-50E		50E-1CL-15.5
ECL155-65E	A155C1D0R0-65E	15HCL-65E		65E-1CL-15.5
ECL155-80E	A155C1D0R0-80E	15HCL-80E		80E-1CL-15.5
ECL155-100E	A155C1D0R0-100E	15HCL-100E		100E-1CL-15.5
ECL155-125E	A155C2D0R0-125E	15HCL-125E		
ECL155-150E	A155C3D0R0-150E	15HCL-150E		
ECL155-200E	A155C3D0R0-200E	15HCL-200E		
ECL155-250E	A155C3D0R0-250E	15HCL-250E		
ECL155-300E	A155C3D0R0-300E	15HCL-300E		
E-Rated fuses for transformers and feeder protection - 2.4kV E-Rated Indoor/Enclosure				
JCX-15E		2CLE-15E		
JCX-20E		2CLE-20E		
JCX-25E		2CLE-25E		
JCX-30E		2CLE-30E	9F60ECB030	30E-1C-2.75
JCX-40E		2CLE-40E	9F60ECB040	40E-1C-2.75
JCX-50E		2CLE-50E	9F60ECB050	50E-1C-2.75
JCX-65E		2CLE-65E	9F60ECB065	65E-1C-2.75
JCX-80E		2CLE-80E	9F60ECB080	80E-1C-2.75
JCX-100E		2CLE-100E	9F60ECB100	100E-1C-2.75
JCX-125E		2CLE-125E	9F60GCB125	125E-1C-2.75
JCX-150E		2CLE-150E	9F60GCB150	150E-1C-2.75
JCX-200E		2CLE-200E	9F60GCB200	200E-1C-2.75
JCX-250E/280X		2CLE-250E		
JCX-300E/325X		2CLE-300E		
JCX-350X		2CLE-350X		
JCX-400X		2CLE-400X		
JCX-450X		2CLE-450X		
E-Rated fuse links for transformers and feeder protection - 5.5kV E-Rated Indoor/Enclosure				
JCU-10E		5CLE-10E-D		
JCU-15E		5CLE-15E		
JCU-20E		5CLE-20E		
JCU-25E		5CLE-25E		
JCU-30E		5CLE-30E-D		
JCU-40E		5CLE1-40E		
JCU-50E		5CLE1-50E		
JCU-65E		5CLE1-65E		
JCU-80E		5CLE1-80E		
JCU-100E		5CLE1-100E		
JCU-125E		5CLE1-125E		
JCU-150E		5CLE-150E		
JCU-175E		5CLE-175E		
JCU-200E		5CLE-200E		
JCU-250E		5CLE-250E		
JCU-300E		5CLE-300E		
JCU-350E		5CLE-350E		
JCU-400E		5CLE-400E		
JCU-450E		5CLE-450E		
JCU-600E		5CLE-600E		
JCU-750E		5CLE-750E		

Cross Reference

US Style E-Rated Fuse Links

Cooper Bussmann	Mersen (Ferraz Shawmut)	Eaton	GE	Littelfuse
E-Rated fuse links for transformers and feeder protection - 8.3kV E-Rated Indoor/Enclosure				
JCZ-15E		8CLE-15E		
JCZ-20E		8CLE-20E		
JCZ-25E		8CLE-25E		
JCZ-30E		8CLE-30E-D		
JCZ-40E		8CLE-40E		
JCZ-50E		8CLE-50E		
JCZ-65E		8CLE-65E		
JCZ-80E		8CLE-80E		
JCZ-100E		8CLE-100E		
JCZ-125E		8CLE-125E		
JCZ-150E		8CLE-150E		
E-Rated fuse links for potential and small power transformers - 2.4kV E-Rated fuse non-indicating				
JCD-1/2E				500E-4PT-2.4
JCD-1E				1E-4PT-2.4
JCD-2E				2E-4PT-2.4
E-Rated fuse links for potential and small power transformers - 5.5kV E-Rated fuse indicating				
JCQ-1/2E			9F60BDD905	1/2E-8PT-5.5
JCQ-1E			9F60BDD001	1E-8PT-5.5
JCQ-3E			9F60BDD003	3E-8PT-5.5
JCQ-5E				5E-8PT-5.5
JCQ-10E				10E-8PT-5.5
E-Rated fuse links for potential and small power transformers - 8.3kV E-Rated fuse indicating				
JCI-1/2E			9F60BDE905	1/2E-8PT-8.25
JCI-3E			9F60BDE003	3E-8PT-8.25
E-Rated fuse links for potential and small power transformers - 15.5kV E-Rated fuse indicating				
JCT-1/2E				1/2E-8PT-8.25
JCT-1E				1E-8PT-15.5
JCT-3E				3E-8PT-15.5
R-Rated fuse links for motor circuit protection - 2.4kV				
JCK-2R	A240R2R	2CLS-2R		70-2R-1C-2.75
JCK-3R	A240R3R	2CLS-3R		100-3R-1C-2.75
JCK-4R	A240R4R	2CLS-4R		130-4R-1C-2.75
JCK-5R	A240R5R	2CLS-5R		150-5R-1C-2.75
JCK-6R	A240R6R	2CLS-6R		170-6R-1C-2.75
JCK-9R	A240R9R	2CLS-9R		200-9R-1C-2.75
JCK-12R	A240R12R	2CLS-12R		230-12R-1C-2.75
JCK-18R	A240R18R	2CLS-18R		390-18R-2C-2.75
JCK-24R	A240R24R	2CLS-24R		450-24R-2C-2.75
R-Rated fuse links for motor circuit protection				
JCK-A-2R		2ACLS-2R		70-2R-1C-2.75w
JCK-A-3R		2ACLS-3R		100-3R-1C-2.75w
JCK-A-4R		2ACLS-4R		130-4R-1C-2.75w
JCK-A-5R		2ACLS-5R		150-5R-1C-2.75w
JCK-A-6R		2ACLS-6R		170-6R-1C-2.75w
JCK-A-9R		2ACLS-9R		200-9R-1C-2.75w
JCK-A-12R		2ACLS-12R		230-12R-1C-2.75w
JCK-A-18R		2ACLS-18R		390-18R-2C-2.75w
JCK-A-24R		2ACLS-24R		450-24R-2C-2.75w
R-Rated fuse links for motor circuit protection				
JCK-B-2R		2BCLS-2R		
JCK-B-3R		2BCLS-3R		
JCK-B-4R		2BCLS-4R		
JCK-B-5R		2BCLS-5R		
JCK-B-6R		2BCLS-6R		
JCK-B-9R		2BCLS-9R		
JCK-B-12R		2BCLS-12R		
JCK-B-18R		2BCLS-18R		
JCK-B-24R		2BCLS-24R		

Cross Reference

US Style E-Rated Fuse Links

Cooper Bussmann	Mersen (Ferraz Shawmut)	Eaton	Littelfuse
R-Rated fuse links for motor circuit protection - 2.4kV Hermetically sealed, for use with ampguard motor starters			
JCH-2R		2HCLS-2R	
JCH-3R		2HCLS-3R	
JCH-4R		2HCLS-4R	
JCH-5R		2HCLS-5R	
JCH-6R		2HCLS-6R	
JCH-9R		2HCLS-9R	
JCH-12R		2HCLS-12R	
JCH-18R		2HCLS-18R	
JCH-24R		2HCLS-24R	
R-Rated fuse links for motor circuit protection - 4.8kV			
JCL-2R	A480R2R-1	5CLS-2R	70-2R-1C-5.5
JCL-3R	A480R3R-1	5CLS-3R	100-3R-1C-5.5
JCL-4R	A480R4R-1	5CLS-4R	130-4R-1C-5.5
JCL-5R	A480R5R-1	5CLS-5R	150-5R-1C-5.5
JCL-6R	A480R6R-1	5CLS-6R	170-6R-1C-5.5
JCL-9R	A480R9R-1	5CLS-9R	200-9R-1C-5.5
JCL-12R	A480R12R-1	5CLS-12R	230-12R-1C-5.5
JCL-18R	A480R18R-1	5CLS-18R	390-18R-2C-5.5
JCL-24R	A480R24R-1	5CLS-24R	450-24R-2C-5.5
R-Rated fuse links for motor circuit protection - 4.8kV with Westinghouse Ampguard Hookeys			
JCL-A-2R	A480R2R-1HE	5ACLS-2R	70-2R-1C-5.5w
JCL-A-3R	A480R3R-1HE	5ACLS-3R	100-3R-1C-5.5w
JCL-A-4R	A480R4R-1HE	5ACLS-4R	130-4R-1C-5.5w
JCL-A-5R	A480R5R-1HE	5ACLS-5R	150-5R-1C-5.5w
JCL-A-6R	A480R6R-1HE	5ACLS-6R	170-6R-1C-5.5w
JCL-A-9R	A480R9R-1HE	5ACLS-9R	200-9R-1C-5.5w
JCL-A-12R	A480R12R-1HE	5ACLS-12R	230-12R-1C-5.5w
JCL-A-18R	A480R18R-1HE	5ACLS-18R	390-18R-2C-5.5w
JCL-A-24R	A480R24R-1HE	5ACLS-24R	450-24R-2C-5.5w
R-Rated fuse links for motor circuit protection - 4.8kV Bolt-on			
JCL-B-2R		5BCLS-2R	70-2R-1BI-5.5
JCL-B-3R		5BCLS-3R	100-3R-1BI-5.5
JCL-B-4R		5BCLS-4R	130-4R-1BI-5.5
JCL-B-5R		5BCLS-5R	150-5R-1BI-5.5
JCL-B-6R		5BCLS-6R	170-6R-1BI-5.5
JCL-B-9R		5BCLS-9R	200-9R-1BI-5.5
JCL-B-12R		5BCLS-12R	230-12R-1BI-5.5
JCL-B-18R		5BCLS-18R	390-18R-2BI-5.5
JCL-B-24R		5BCLS-24R	450-24R-2BI-5.5
R-Rated fuse links for motor circuit protection - 4.8kV Hermetically sealed for use with ampguard motor starters			
JCG-2R		5HCLS-2R	
JCG-3R		5HCLS-3R	
JCG-4R		5HCLS-4R	
JCG-5R		5HCLS-5R	
JCG-6R		5HCLS-6R	
JCG-9R		5HCLS-9R	
JCG-12R		5HCLS-12R	
JCG-18R		5HCLS-18R	
JCG-24R		5HCLS-24R	
R-Rated fuse links for motor circuit protection - 7.2kV with ampguard			
JCR-A-2R		8ACLS-2R	70-2R-1C-8.25w
JCR-A-3R		8ACLS-3R	100-3R-1C-8.25w
JCR-A-4R		8ACLS-4R	130-4R-1C-8.25w
JCR-A-5R		8ACLS-5R	150-5R-1C-8.25w
JCR-A-6R		8ACLS-6R	170-6R-1C-8.25w
JCR-A-9R		7ACLS-9R	200-9R-1C-8.25w
JCR-A-12R		7ACLS-12R	230-12R-1C-8.25w
JCR-A-18R		7ACLS-18R	390-18R-2C-8.25w
JCR-A-24R		7ACLS-24R	450-24R-2C-8.25w

Cross Reference

US Style E-Rated Fuse Links

Cooper Bussmann	Mersen (Ferraz Shawmut)	Eaton	Littelfuse
R-Rated fuse links for motor circuit protection - 7.2kV Bolt-On			
JCR-B-2R	A072B1DAR0-2R	7BCLS-2R	70-2R-1BI-8.25
JCR-B-3R	A072B1DAR0-3R	7BCLS-3R	100-3R-1BI-8.25
JCR-B-4R	A072B1DAR0-4R	7BCLS-4R	130-4R-1BI-8.25
JCR-B-5R	A072B1DAR0-5R	7BCLS-5R	150-5R-1BI-8.25
JCR-B-6R	A072B1DAR0-6R	7BCLS-6R	170-6R-1BI-8.25
JCR-B-9R	A072B1DAR0-9R	7BCLS-9R	200-9R-1BI-8.25
JCR-B-12R	A072B1DAR0-12R	7BCLS-12R	230-12R-1BI-8.25
JCR-B-18R	A072B2DAR0-18R	7BCLS-18R	390-18R-2BI-8.25
JCR-B-24R	A072B2DAR0-24R	7BCLS-24R	450-24R-2BI-8.25
ANSI R-Rated fuse links for motor circuit protection - 2.4kV system voltage			
2.75VFRHA2R	A240R2R	2CLS-2R	70-2R-1C-2.75
2.75VFRHA3R	A240R3R	2CLS-3R	100-3R-1C-2.75
2.75VFRHA4R	A240R4R	2CLS-4R	130-4R-1C-2.75
2.75VFRHA6R	A240R6R	2CLS-6R	170-6R-1C-2.75
2.75VKRNA9R	A240R9R	2CLS-9R	200-9R-1C-2.75
2.75VKRNA12R	A240R12R	2CLS-12R	230-12R-1C-2.75
2.75VKRHK18R	A240R18R	2CLS-18R	390-18R-2C-2.75
2.75VKRHK24R	A240R24R	2CLS-24R	450-24R-2C-2.75
ANSI R-Rated fuse links for motor circuit protection - 4.8kV system voltage			
5.5VFNHA2R	A480R2R-1	5CLS-2R	70-2R-1C-5.5
5.5VFNHA3R	A480R3R-1	5CLS-3R	100-3R-1C-5.5
5.5VFNHA4R	A480R4R-1	5CLS-4R	130-4R-1C-5.5
5.5VFNHA6R	A480R6R-1	5CLS-6R	170-6R-1C-5.5
5.5VKNNA9R	A480R9R-1	5CLS-9R	200-9R-1C-5.5
5.5VKNNA12R	A480R12R-1	5CLS-12R	230-12R-1C-5.5
5.5VKNHK18R	A480R18R-1	5CLS-18R	390-18R-2C-5.5
5.5VKNHK24R	A480R24R-1	5CLS-24R	450-24R-2C-5.5

Cross Reference

Boric Acid Fuse Links

Part Number	S & C Electric Company
17kV	
BBU17-3K	702003
BBU17-6K	702006
BBU17-8K	702008
BBU17-10K	702010
BBU17-12K	702012
BBU17-15K	702015
BBU17-20K	702020
BBU17-25K	702025
BBU17-30K	702030
BBU17-40K	702040
BBU17-50K	702050
BBU17-65K	702065
BBU17-80K	702080
BBU17-100K	702100
BBU17-140K	702140
BBU17-200K	702200
BBU17-5E	612005
BBU17-7E	612007
BBU17-10E	612010
BBU17-13E	612013
BBU17-15E	612015
BBU17-20E	612020
BBU17-25E	612025
BBU17-30E	612030
BBU17-40E	612040
BBU17-50E	612050
BBU17-65E	612065
BBU17-80E	612080
BBU17-100E	612100
BBU17-125E	612125
BBU17-150E	612150
BBU17-175E	612175
BBU17-200E	612200
BBU17-15SE	712015
BBU17-20SE	712020
BBU17-25SE	712025
BBU17-30SE	712030
BBU17-40SE	712040
BBU17-50SE	712050
BBU17-65SE	712065
BBU17-80SE	712080
BBU17-100SE	712100
BBU17-125SE	712125
BBU17-150SE	712150
BBU17-175SE	712175
BBU17-200SE	712200

Part Number	S & C Electric Company
27kV	
BBU27-3K	703003
BBU27-6K	703006
BBU27-8K	703008
BBU27-10K	703010
BBU27-12K	703012
BBU27-15K	703015
BBU27-20K	703020
BBU27-25K	703025
BBU27-30K	703030
BBU27-40K	703040
BBU27-50K	703050
BBU27-65K	703065
BBU27-80K	703080
BBU27-100K	703100
BBU27-140K	703140
BBU27-200K	703200
BBU27-5E	613005
BBU27-7E	613007
BBU27-10E	613010
BBU27-13E	613013
BBU27-15E	613015
BBU27-20E	613020
BBU27-25E	613025
BBU27-30E	613030
BBU27-40E	613040
BBU27-50E	613050
BBU27-65E	613065
BBU27-80E	613080
BBU27-100E	613100
BBU27-125E	613125
BBU27-150E	613150
BBU27-175E	613175
BBU27-200E	613200
BBU27-15SE	713015
BBU27-20SE	713020
BBU27-25SE	713025
BBU27-30SE	713030
BBU27-40SE	713040
BBU27-50SE	713050
BBU27-65SE	713065
BBU27-80SE	713080
BBU27-100SE	713100
BBU27-125SE	713125
BBU27-150SE	713150
BBU27-175SE	713175
BBU27-200SE	713200

Part Number	S & C Electric Company
38kV	
BBU38-3K	704003
BBU38-6K	704006
BBU38-8K	704008
BBU38-10K	704010
BBU38-12K	704012
BBU38-15K	704015
BBU38-20K	704020
BBU38-30K	704030
BBU38-40K	704040
BBU38-50K	704050
BBU38-65K	704065
BBU38-80K	704080
BBU38-100K	704100
BBU38-140K	704140
BBU38-200K	704200
BBU38-5E	614005
BBU38-7E	614007
BBU38-10E	614010
BBU38-13E	614013
BBU38-15E	614015
BBU38-20E	614020
BBU38-25E	614025
BBU38-30E	614030
BBU38-40E	614040
BBU38-50E	614050
BBU38-65E	614065
BBU38-80E	614080
BBU38-100E	614100
BBU38-125E	614125
BBU38-150E	614150
BBU38-175E	614175
BBU38-200E	614200
BBU38-15SE	714015
BBU38-20SE	714020
BBU38-25SE	714025
BBU38-30SE	714030
BBU38-40SE	714040
BBU38-50SE	714050
BBU38-65SE	714065
BBU38-80SE	714080
BBU38-100SE	714100
BBU38-125SE	714125
BBU38-150SE	714150
BBU38-175SE	714175
BBU38-200SE	714200

Time-Current Curves and Cut-Off Curves List

kV	Product Range	Page Number	Fuse Type	Time-Current Curve Reference	Cut-Off Curve Reference
DIN Fuse Links					
3.6	'A' and 'W' range	15	ADL	PF1001	N/A
3.6	'A' and 'W' range	15	ADO, WDO, WFO	PF1002	PF2002
7.2	'T' range	16	TDL, TFL	PF1042	PF2042
12	Full range	17	FFL	PF1067	PF2067
		17	FDL	PF1124	PF2124
		17	FXL	PF1242	PF2242
12	'A' and 'T' range	18	AIL	PF1129	N/A
		18	TXL	PF1197	PF2197
		18	TDL, THL, TKL	PF1275	PF2275
		18	TFM, THM, TKM	PF1280	PF2280
17.5	'A' and 'T' range	19	AIL	PF1006	PF2006
		19	AIM	PF1005	N/A
		19	TDL	PF1088	PF2088
		19	TFL	PF1246	PF2246
		19	TDM, THM, TKM	PF1274	PF2274
24	Full range	21	FDM, FFM	PF1119	PF2119
24	'A' and 'T' range	22	AFM, AIM	PF1007	PF2007
		22	TFM, TXM	PF1236	PF2236
		22	TDM, THM, TFM	PF1276	PF2276
36	'T' range	23	TDQ, TFQ	PF1046	PF2046
		23	TXQ	PF1253	PF2253
Motor Fuse Links					
3.6	BS range	28	WJON	PF1079	N/A
		28	WDO, WFO	PF1002	PF2002
7.2	Motor BS range	30	WFN, WKN	PF1018	PF2018
3.6	Motor DIN range	31	WDO, WFO	PF1002	PF2002
		31	WDL, WFL, WKL	PF1001	N/A
7.2	Motor DIN range	32	WFM, WKM	PF1018	PF2018
Voltage and Auxiliary Transformer (V and T) Fuse Links					
1.1	'V' and 'T' range	37	NBU	PF1019	N/A
3.6	'V' and 'T' range	38	ABW, ABC	PF1020	PF2020
5.5	'E' range	39	ABW	PF1081, PF1082	PF2081
		39	AMW	PF1102, PF1103	PF2102
7.2	'V' and 'T' range	40	ABC, ABW, OBC, OBW	PF1021	PF2021
12	'V' and 'T' range	41	ABC, OBC	PF1022	PF2022
15.5	'V' and 'T' range	42	ABF, OBF	PF1061	N/A
17.5	'V' and 'T' range	43	ABG, OBG	PF1023	PF2023
24	'V' and 'T' range	44	ABG, OBG	PF1024	PF2024
36	'V' and 'T' range	45	OBG	PF1060	N/A
3.6	CAV range	46	CAV	PF1251	N/A
5.5	CAV range	47	CAV	PF1154, PF1155	N/A
		47	CAVH	PF1126	PF2126
7.2	CAV range	48	CAV	PF1250	N/A
12	CAV range	49	CAV	PF1249	N/A
15.5	CAV and CAVH range	50	CAV	PF1152, PF1153	N/A
		50	CAVH	PF1126, PF1127	PF2126
17.5	CAV range	51	CAV	PF1226	N/A
24	CAV range	52	CAV	PF1248	N/A
36	CAV range	53	CAV	PF1223	N/A
38	CAV and CAVH range	54	CAV	PF1156, PF1157	N/A
		54	CAVH	PF1126, PF1127	PF2126

Time-Current Curves and Cut-Off Curves List

kV	Product Range	Page Number	Fuse Type	Time-Current Curve Reference	Cut-Off Curve Reference
Oil Fuse Links					
3.6	BS range	57	OEF, OEG, OLG	PF1025	PF2025
7.2	BS range	58	OEF	PF1058	PF2058
		58	OHG	PF1064	PF2064
12	BS range	59	OEF, OHF	PF1053	PF2053
		59	OHG, OLG	PF1117	N/A
15.5	BS range	60	OEF, OHG, OLG	PF1056	PF2056
17.5	BS range	61	OHG	PF1057	PF2057
24	BS range	62	OEG	PF1059	PF2059
Air Fuse Links					
3.6	BS	66	ADG	PF1008	PF2008
		66	ADF	PF1247	N/A
7.2	BS range	68	ADF, AFF	PF1256	PF2256
		68	BDG, BFG	PF1009	PF2009
12	BS range	70	ADF, AFF	PF1261	N/A
		70	BDG, BFG, AKG	PF1010	PF2010
		70	FFG	PF1068	PF2068
15.5	BS range	72	BDG, BFG	PF1011	PF2011
24	BS range	73	ADI, AFI	PF1012	PF2012
		73	FDIHA	PF1094	N/A
36	BS range	74	ADI, AFI, AFK	PF1013	PF2013
72.5	BS range	75	AFK	PF1014	PF2014
E-rated Fuse Links					
5.5	DIN (single barrel)	77	GFM, GDM	PF1216, PF1217	PF2217
	DIN (double barrel)	77	GFM, GDM	PF1220, PF1221	PF2220
15.5	DIN (single barrel)	77	GXQ	PF1218, PF1219	PF2219
	DIN (double barrel)	77	GXQ	PF1224, PF1225	N/A
17.5	DIN (single barrel)	78	GDM, GFM, GXM, GXQ	PF1218, PF1219	N/A
	DIN (double barrel)	78	GDM, GFM, GXM, GXQ	PF1224, PF1225	PF2224
25.8	DIN (single barrel)	78	GDQ, GXQ, GXZ	PF1254, PF1255	PF2254
	DIN (double barrel)	78	GDQ, GXQ, GXZ	PF1257, PF1258	PF2257
38	DIN (single barrel)	78	GFZ, GXZ	PF1254, PF1255	PF2254
	DIN (double barrel)	78	GFZ, GXZ	PF1257, PF1258	PF2257
5.5	E-rated for transformers	79	FFN	PF1107, PF1108	PF2107
	E-rated for transformers	79	BFN, BKN	PF1114, PF1115	N/A
8.25	E-rated for transformers	81	FFN	PF1107, PF1108	PF2107
	E-rated for transformers	81	BFN	PF1112, PF1113	N/A
15.5	E-rated for transformers	82	FFV	PF1107, PF1108	PF2107
5.5	E-rated for Potential and Small Power Transformers	87	AMWNA	PF1102, PF1103	PF2102
		87	ABWNA	PF1081, PF1082	PF2081
		87	CAV	PF1154, PF1155	N/A
		87	CAVH	PF1126, PF1127	PF2126
7.2	As above	87	AMWN	PF1277, PF1278	PF2277
15.5	E-rated for Potential and Small Power Transformers	87	CAV	PF1152, PF1153, PF1268, PF1269	N/A
		87	CAVH	PF1126, PF1127	PF2126
38	E-rated for Potential and Small Power Transformers	87	CAV	PF1156, PF1157	N/A
		87	CAVH	PF1126, PF1127	PF2126
Expulsion Fuse Links					
15kV to 72kV Expulsion Fuse Links		96	Type T & K	PF1047, PF1049	N/A

Index

Part Number	Page	Part Number	Page	Part Number	Page	Part Number	Page
1.1NBUN	37	2.75VKRH	33	36TDQSJ	23	JCG	91 & 93
12ABCN	41	24ABGN	44	36TFQSJ	23	JCH	91-92
12ADFH	70-71	24ADIH	73	36TXQEJ	23	JCI	86
12AFFH	70-71	24AFIH	73	38CAV	54 & 87	JCK	91-92
12AISLJ	18	24AFMSJ	22	38GFZSJ	77-78	JCL	91-92
12AKGH	70-71	24AIMSJ	22	38GXZSJ	77-78	JCL-A	91 & 93
12BDGH	70-71	24CAV	52	5.5ABWN	39 & 87	JCL-B	91 & 93
12BFGH	70-71	24FDIH	73	5.5AMWN	39 & 87	JCQ	86
12CAV2	49	24FDMSJ	21	5.5BFNH	79-80	JCR	91 & 93
12FDLSJ	17	24FFMSJ	21	5.5BKNH	79-80	JCT	86
12FFGN	70-71	24OBGN	44	5.5CAV	47 & 87	JCU	84-85
12FFLSJ	17	24OEGM	62	5.5FFNH	79-80	JCW	86
12FXLSJ	17	24TDMEJ	22	5.5VFNH	34	JCX	84
12OBCN	41	24TFMEJ	22	5.5VKNH	34	JCY	84-85
12OEFM	59	24THMEJ	22	55GDMSJ	77	JCZ	84-85
12OHFM	59	24TXMEJ	22	55GFMSJ	77	JDZ	84-85
12OHGM	59	258GDQSJ	77-78	7.2ABCN	40	KB**	96-97
12OLGM	59	258GXQSJ	77-78	7.2ABWN	40	KBR**	96-97
12TDLEJ	18	258GXZSJ	77-78	7.2ADFH	68-69	KD**	96-97
12TFMSJ	18	270303	94-95	7.2AFFH	68-69	KU**	96-97
12THLEJ	18	3.6ABCN	38	7.2AMWN	40 & 87	MV055	79-80
12THMEJ	18	3.6ABWN	38	7.2BDGH	68-69	MV155	82-83
12TKLEJ	18	3.6ADFH	66-67	7.2BFGH	68-69	SB**	96-97
12TXLEJ	18	3.6ADGH	66-67	7.2CAV	48	SBR**	96-97
15.5ABFN	42	3.6ADLSJ	15	7.2OBCN	40	SD**	96-97
15.5BDGH	72	3.6ADOSJ	15	7.2OBWN	40	SU**	96-97
15.5BFGH	72	3.6CAV2	46	7.2OEFM	58	TB**	96-97
15.5CAV	50 & 87	3.6OEFM	57	7.2OHGM	58	TBR**	96-97
15.5FFVH	82-83	3.6OEGM	57	7.2DLSJ	16	TD**	96-97
15.5OBFN	42	3.6OLGM	57	7.2TFLSJ	16	TU**	96-97
15.5OEFM	60	3.6WDFH	28-29	7.2WFMSJ	32	XAB**	96-97
15.5OHGM	60	3.6WDLSJ	31	7.2WFNH	30	XABR**	96-97
15.5OLGM	60	3.6WDOH	28-29	7.2WKMSJ	32	XAD**	96-97
155GXQSJ	77	3.6WDOSJ	15 & 31*	7.2WKNH	30	XAU**	96-97
17.5ABGN	43	3.6WFFH	28-29	72.5AFKH	75		
17.5AILSJ	19-20	3.6WFGH	28-29	8.25BFNH	81		
17.5AIMSJ	19-20	3.6WFLSJ	31	8.25FFNH	81		
17.5CAV	51	3.6WFOH	28-29	A3354705	94-95		
17.5OBGN	43	3.6WFOSJ	15 & 31*	A3354710	94-95		
17.5OHGM	61	3.6WJON	28-29	A3354720	94-95		
17.5TDLSJ	19-20	3.6WKFGH	28-29	A3354730	94-95		
17.5TDMEJ	19-20	3.6WKFH	28-29	A3354745	94-95		
17.5TFLSJ	19-20	3.6WKGH	28-29	ASL	98-101		
17.5THMEJ	19-20	3.6WKLSJ	31	BBU	102-108		
17.5TKMEJ	19-20	36ADIH	74	ECL055	88		
175GDMSJ	77-78	36AFIH	74	ECL083	89		
175GFMSJ	77-78	36AFKH	74	ECL155	90		
175GXQSJ	77-78	36CAV	53	JCD	86		
2.75VFRH	33	36OBGN	45	JCE	86		

* Page 15: DIN Fuse Link, Page 31 DIN Motor Fuse Link

** Expulsion Fuse Links

Customer Assistance

Customer Satisfaction Team

The Cooper Bussmann® Customer Satisfaction Team is available to answer questions regarding Cooper Bussmann products.

Calls can be made between:

Europe:

Monday-Thursday 7:30 a.m. - 5:30 p.m. GMT

Friday 7:30 a.m. - 5:00 p.m. GMT

The Customer Satisfaction Team can be reached via:

- Phone: 00 44 (0) 1509 882 600
- Fax: 00 44 (0) 1509 882 786
- E-mail: buleksales@cooperindustries.com

C³ Cooper Customer Center

The Cooper C³ portal supports the following Cooper Divisions: Cooper B-Line, Cooper Bussmann, Cooper Crouse-Hinds, Cooper Lighting, Cooper Power Systems, Cooper Safety, and Cooper Wiring Devices. Get started today at WWW.COOPERC3.COM by clicking Request User ID and Password.

- Easy to Navigate
- Simple to Use
- Real-Time Data

Application Engineering

Application Engineering assistance is available to all customers. The Application Engineering team is staffed by university-qualified electrical engineers who are available by phone with technical and application support.

Europe:

Monday – Thursday 8:30 a.m. – 4:30 p.m. GMT

Friday 8:30 a.m. - 4:00 p.m. GMT

Application Engineering can be reached via phone, fax or email:

- Phone: 00 44 (0) 1509 882 699
- Fax: 00 44 (0) 1509 882 794
- E-mail: buletechnical@cooperindustries.com

Online Resources

Visit www.cooperbussmann.com for the following resources:

- Product Cross Reference
- Product Data Sheets
- Product Profiles
- Online catalogues for the latest United States and European Catalogues

Your authorised Cooper Bussmann Distributor is



© Cooper Bussmann (UK) Ltd

Melton Road
Burton-on-the-Wolds, LE12 5TH, United Kingdom
P: 00 44 (0) 1509 882 600
www.cooperbussmann.com

Reorder #: MVFL1111

 **COOPER Bussmann**